



BOTANICAL GARDEN

# TROPICAL FLOWER BOUQUET

YOU'RE ALWAYS ON MY MIND



[ A ]

EDUCIRO



INSTRUCTIONS

14+ | B824 | 891pcs

## Bird of paradise flower

The bird of paradise flower (*Strelitzia reginae* Aiton) comes from southern Africa. It has a flame like appearance, very tall and elegant, vibrantly real colors, giving hope and peace.



## Yellow rain lily

The yellow rain lily flower (*Zephyranthes citrina*) is a symbol of hope, renewal, and rejuvenation. It is often associated with new beginnings, fresh starts, and the coming of spring.

The bright yellow color of the flower is also thought to represent happiness, joy, and optimism.



## Frangipani

Frangipani(Plumeria) is commonly associated with new beginnings and the start of a new chapter in life. In many cultures, it is used in wedding ceremonies and other celebrations to represent the couple's new beginning together or to wish someone luck as they embark on a new journey.



# Thank you for choosing EDUCIRO.

About Us: We are Educiro! We create quality building toys and science kits that are both entertaining and educational. Our products are worth every penny and full of clever details. Our company develops the coolest products for kids and adults because they know that if you want to grow your brain and be the smartest one in the room, you are only going to do it if it's fun!

This unique home decor gift is perfect for adults and kids alike, fostering bonding and fun when building. It is reusable and a match material for flower lovers to complement other types of building block flowers.

If you are not satisfied with the kit, we will refund you 100% of the money, no questions asked.

**EDUCIRO**

Certification:



Share your photos and video with us by posting with @EDUCIRO or #EDUCIRO

Official Website: [www.educiro.com](http://www.educiro.com)

**Our services at: [Support@educiro.com](mailto:Support@educiro.com)**

Find building instructions online; let us know if a brick has broken;  
tell us if something is missing from your new set.

**How to Service?**

Tell us with theme name (EDUCIRO TROPICAL FLOWER BOUQUET)

Or set number (Educiro B824) and you'll get instruction  
manuals and customer service for new sets.



Searching "EDUCIRO" shows all the products and discounts

**BIGGEST OFFER**  
**EVERYDAY**  
**UP TO 50%**  
**DISCOUNT**



# COLOR REFERENCE

Brick Colors **VS** Print Colors

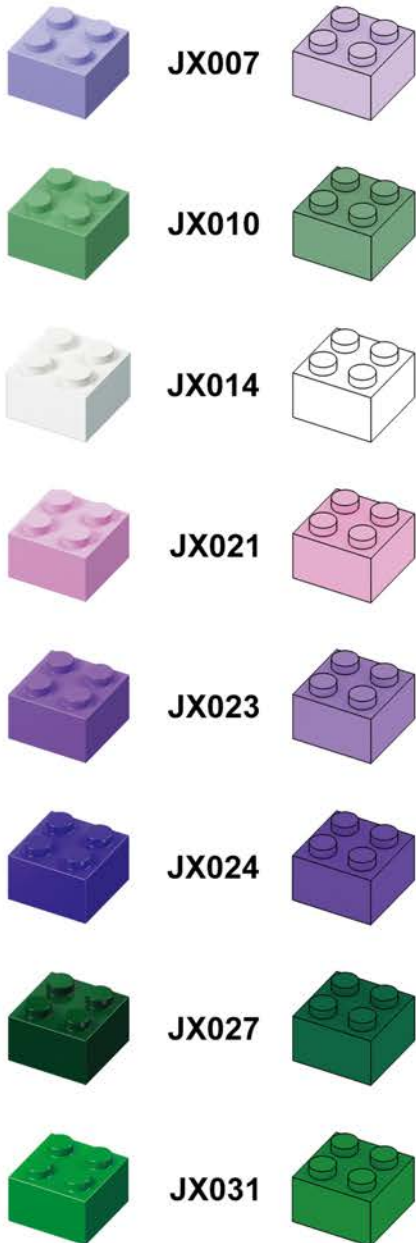

Brick Colors **VS** Print Colors

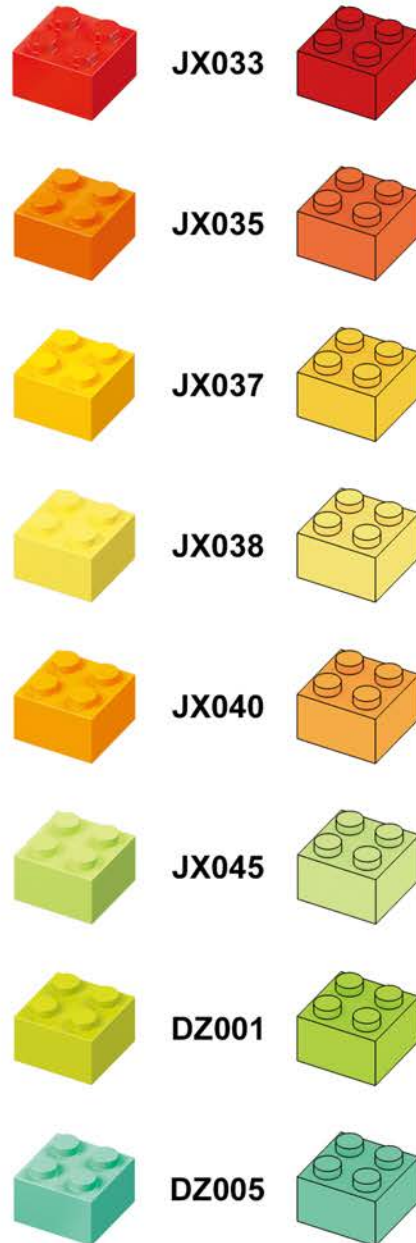

1

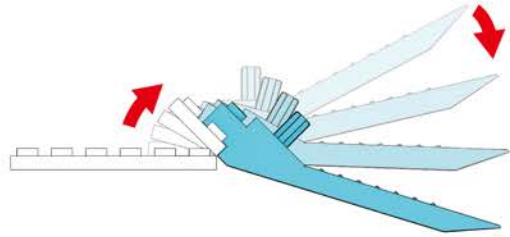
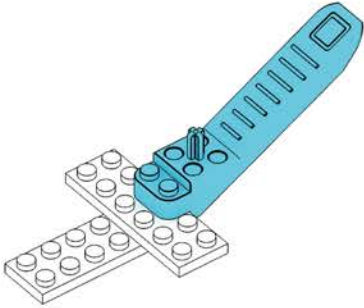

2

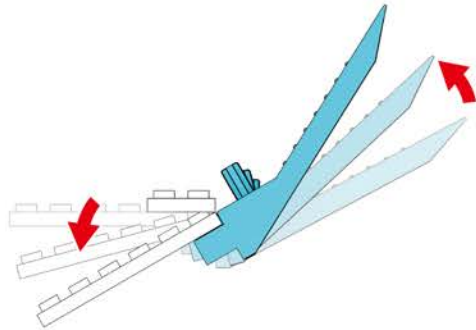
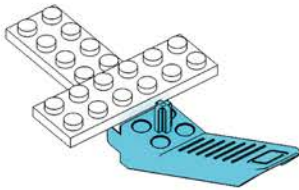

3

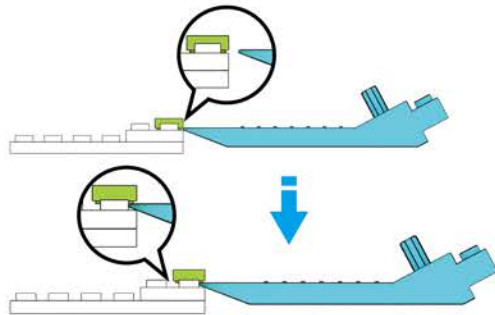
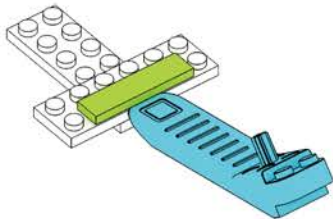

4

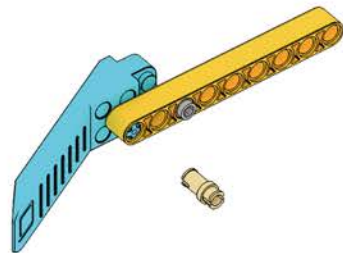
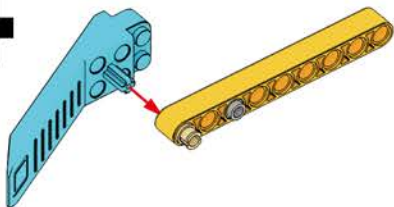





# Quick Start Guide

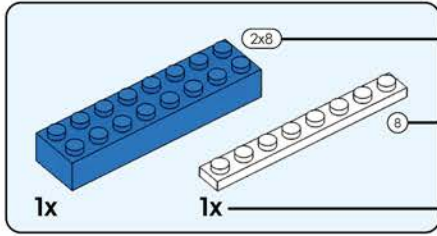

2\*8 shows that the width of the part is 2 block particles and the length is 8 block particles.

8 means that the length is 8 block particles.

The number of parts required for this step.

**XX** | Build in numerical order.

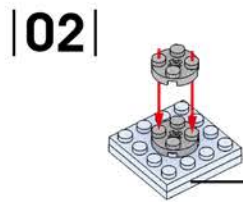
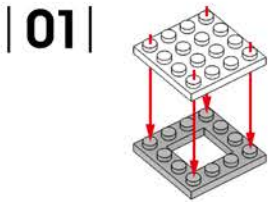

The assembled bricks are shown in light color.

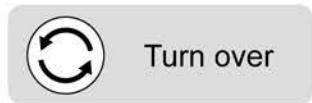

Turn over



Sticker

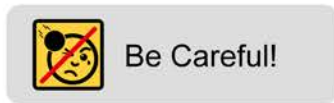

Be Careful!

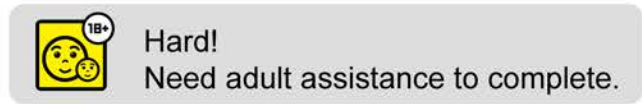

Hard!  
Need adult assistance to complete.

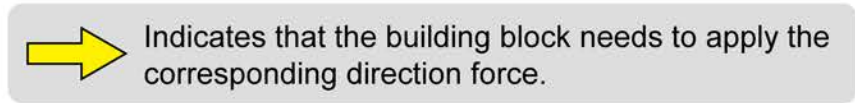

Indicates that the building block needs to apply the corresponding direction force.

## 1:1 Label Length Comparison

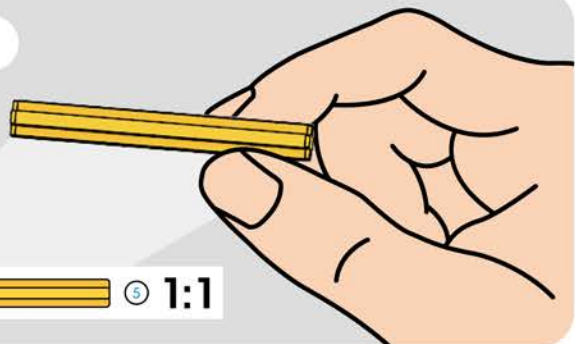
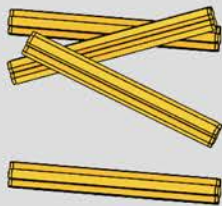

Building Suggestion  
and After-Sales Service

Unpack  
according to the  
order of building  
block bags



1

Sort by part  
color or shape

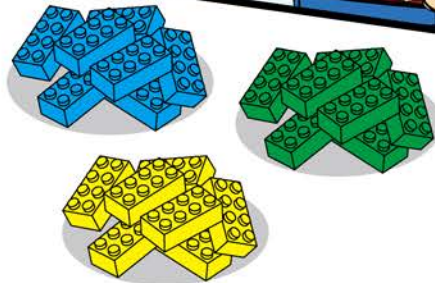

2

Sort the parts  
according to the  
instructions

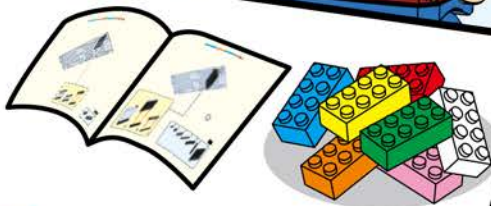
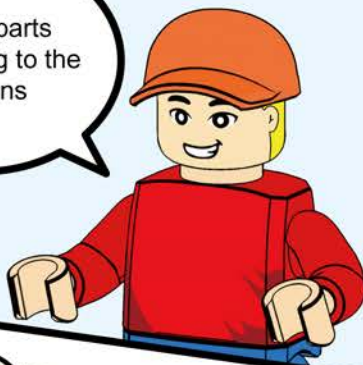

3



1. Get instructions PLUS.
2. Get building video.
3. More products.
4. Give us your short feedback about our products.

... This set contains the following brick bags ...

Assemble most modules shown in the picture using the parts from the numbered brick packages (\*some parts may be in the general brick package).

Create a collaborative family project with multiple participants.



## CONTENTS

Part 1.....

1

Part 2.....

19

Part 3.....

33

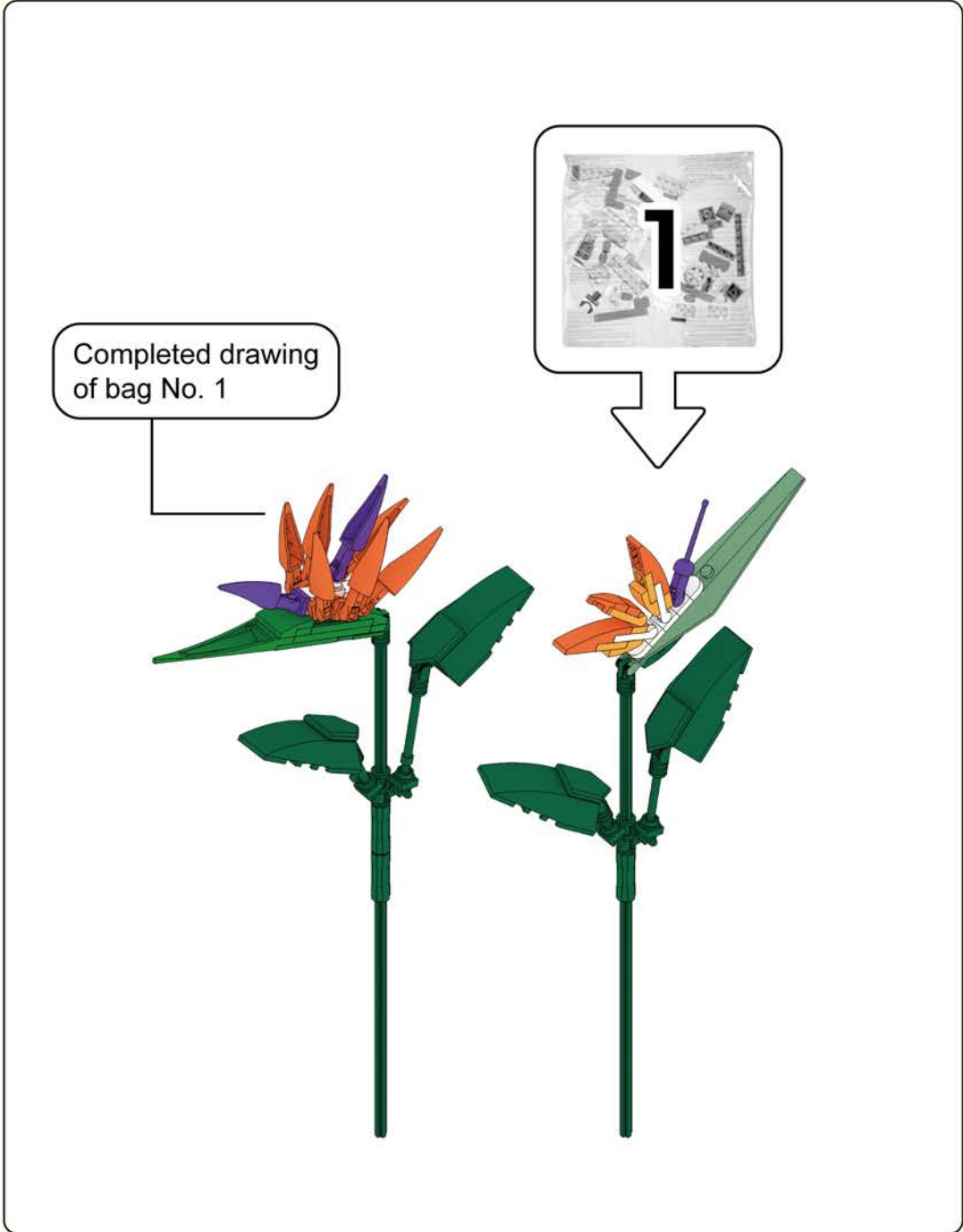



The module to be built

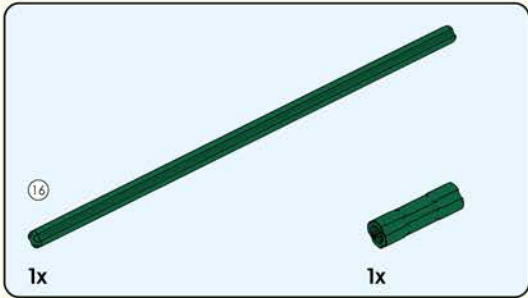

| 01 |



02

ONLINE [www.educiro.com](http://www.educiro.com)

Customer Service [support@educiro.com](mailto:support@educiro.com)

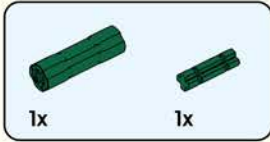

| 02 |



The assembled bricks are shown in light color.

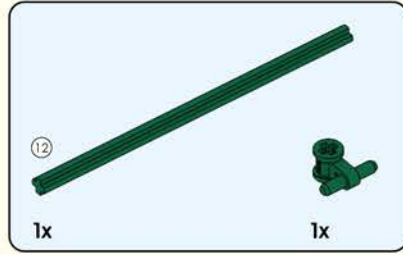

| 03 |

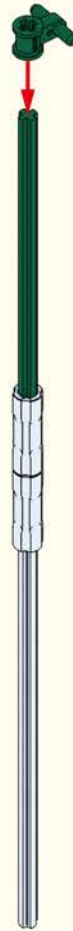

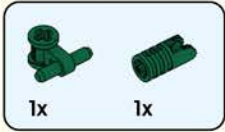

|04|

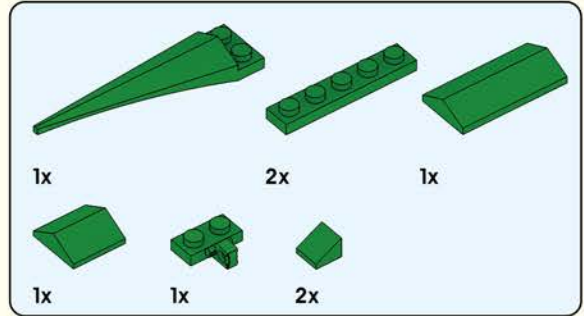
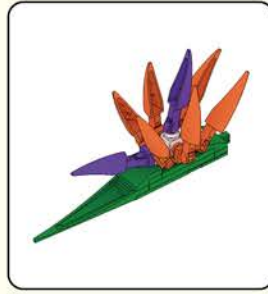
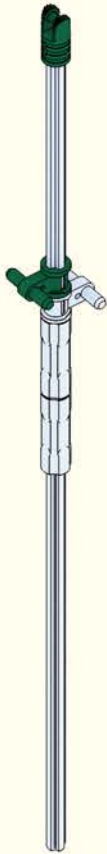

|05|

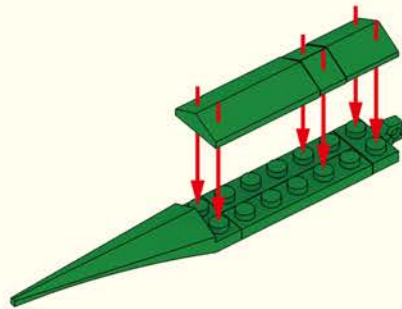

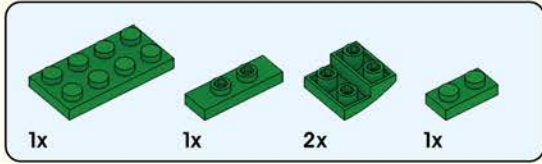

|06|

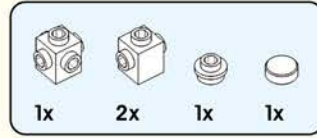
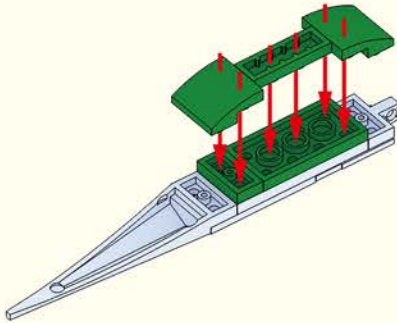

|07|

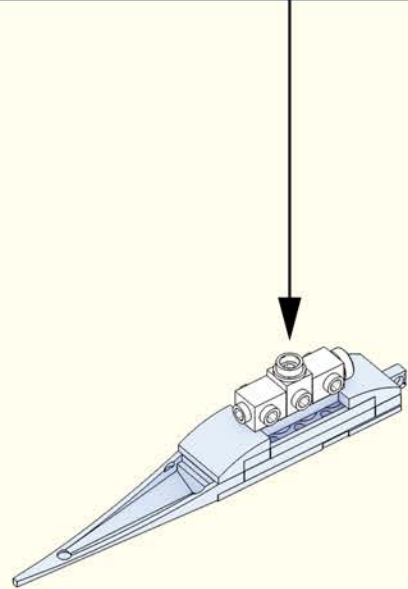
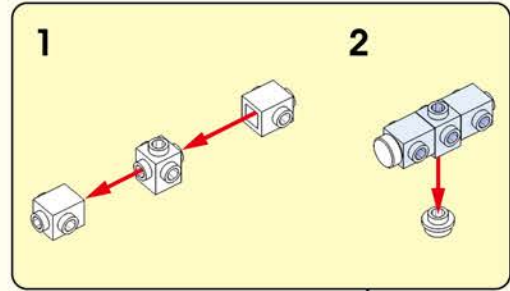

05

ONLINE [www.educiro.com](http://www.educiro.com)

Customer Service [support@educiro.com](mailto:support@educiro.com)



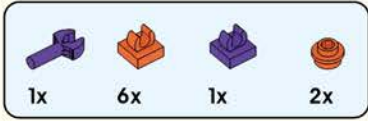

**|08|**

Indicates the number of times the module needs to be built repeatedly

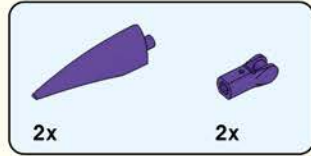
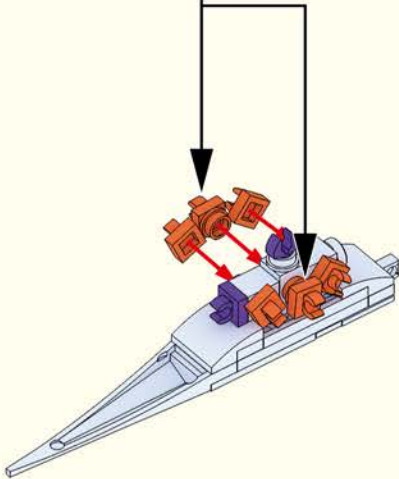
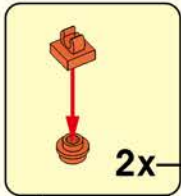

**|09|**

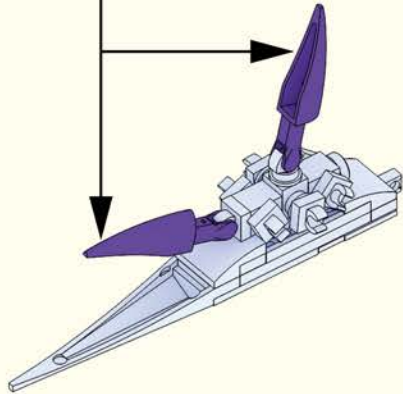
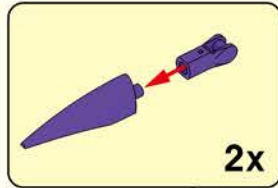

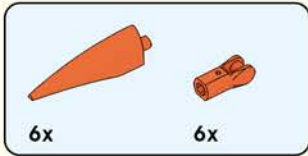

| 10 |

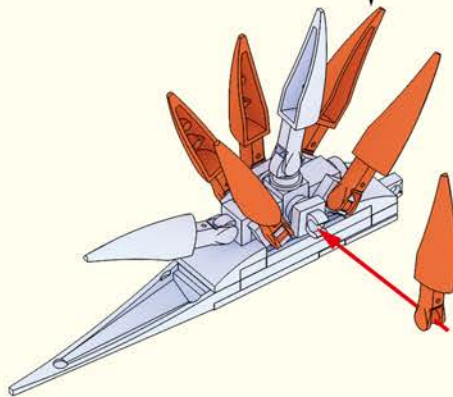
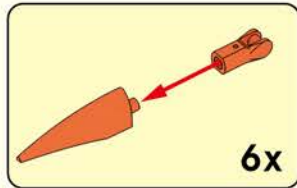

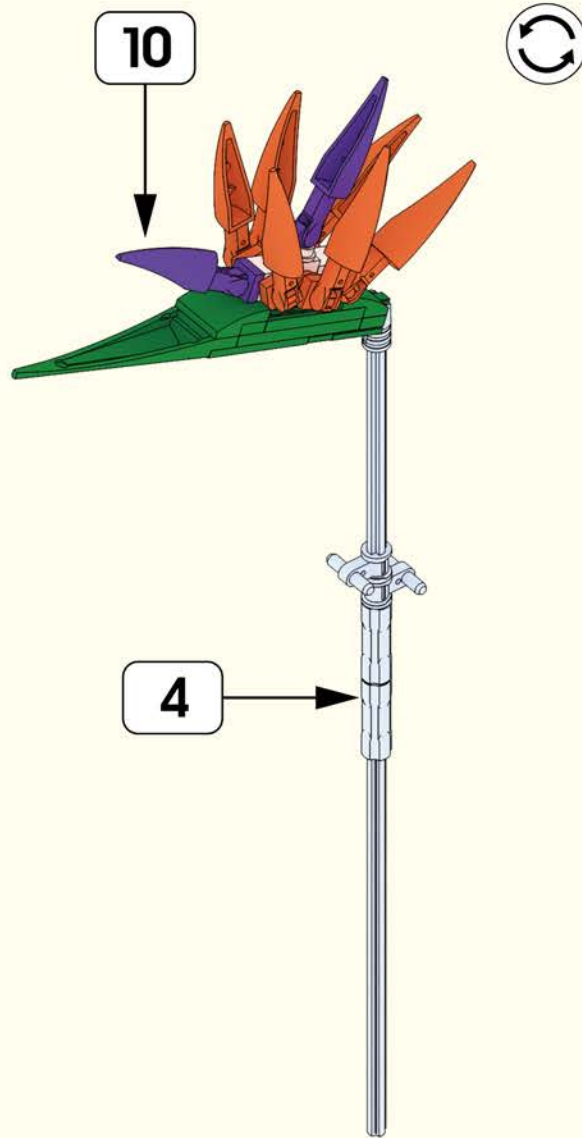

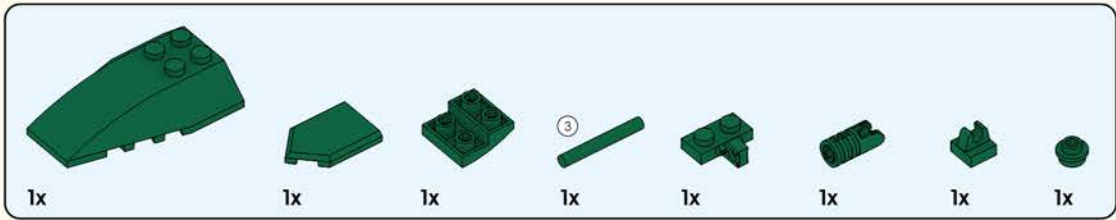

**| 12 |**

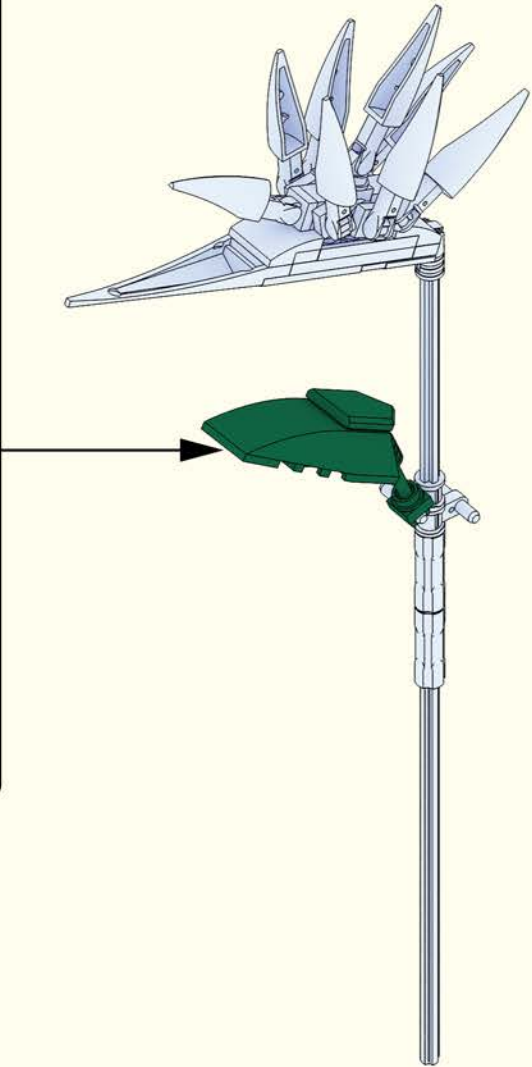
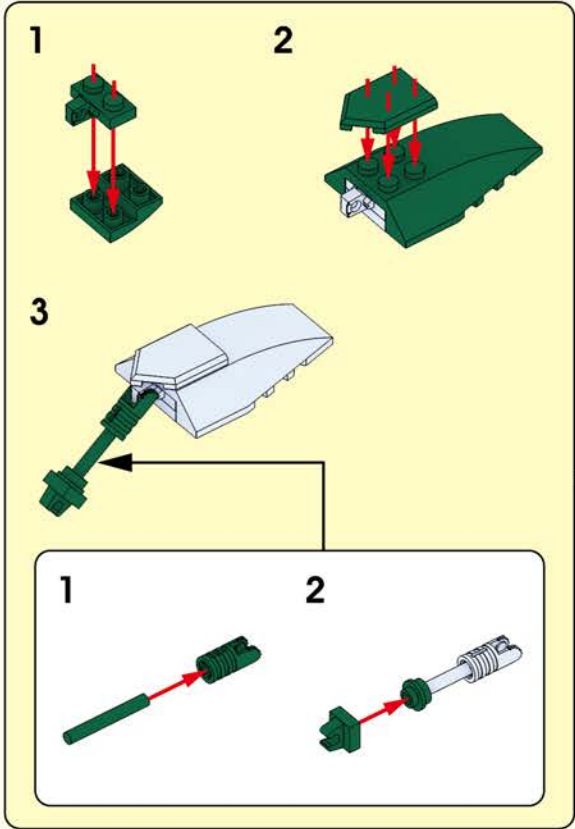

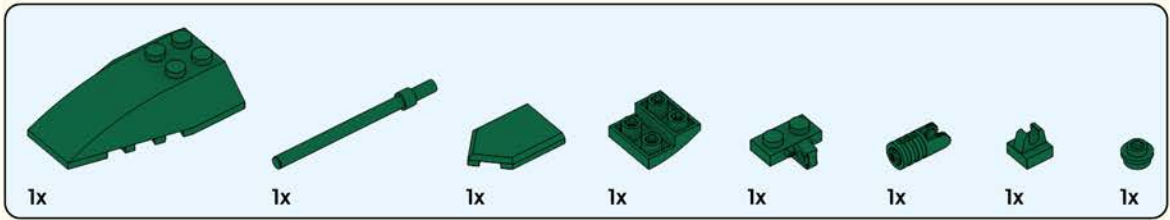

# 13

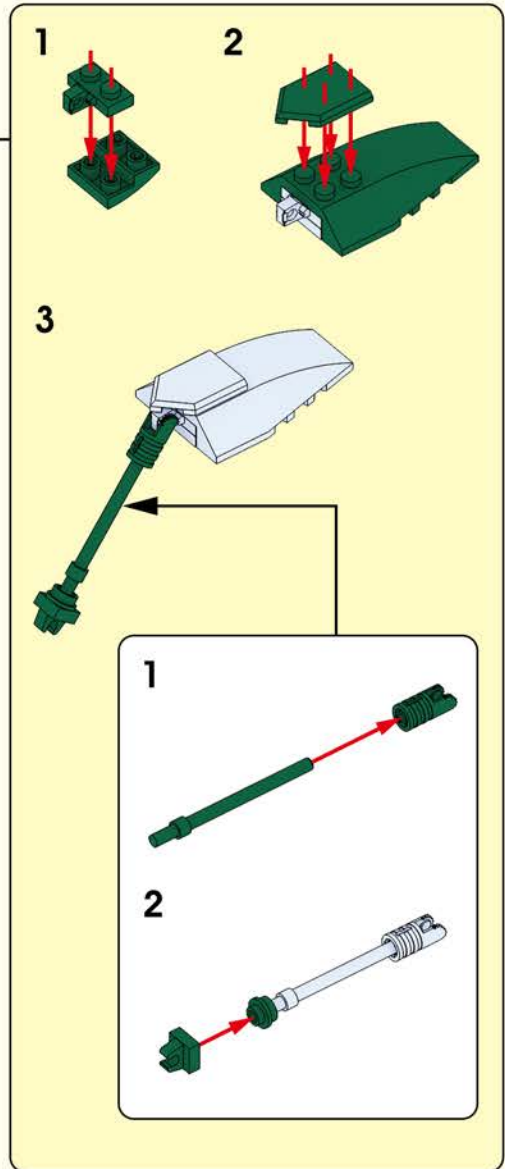
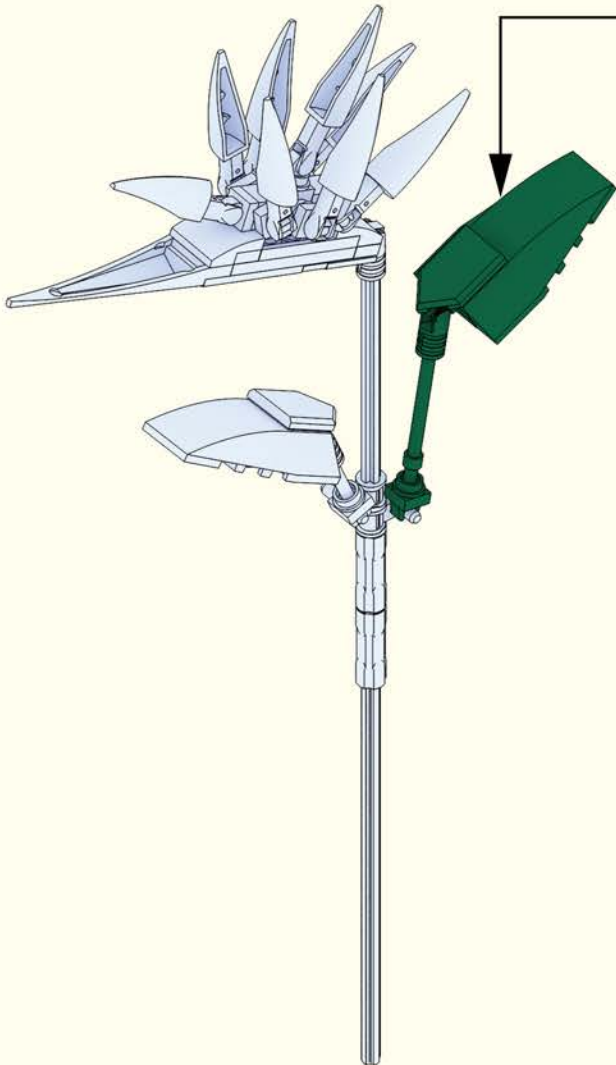

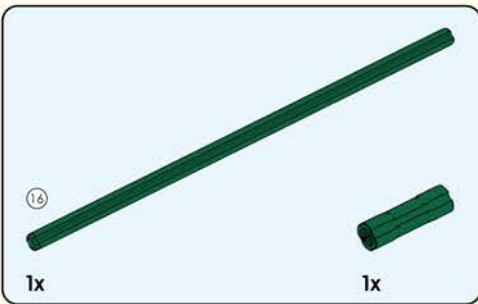

| 14 |



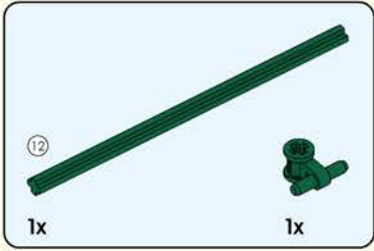

| 15 |

1:1

12

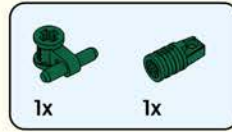
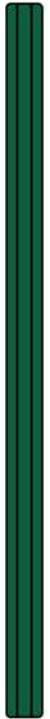

| 16 |

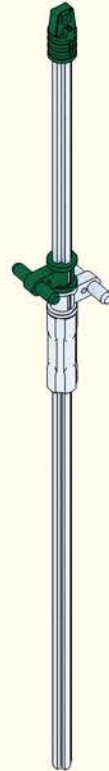

12

ONLINE [www.educiro.com](http://www.educiro.com)

Customer Service [support@educiro.com](mailto:support@educiro.com)

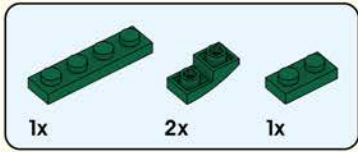
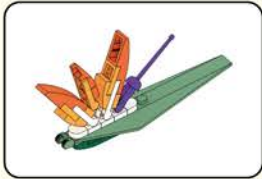

| 17 |

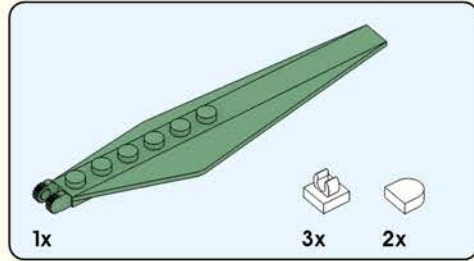
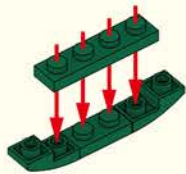

| 18 |

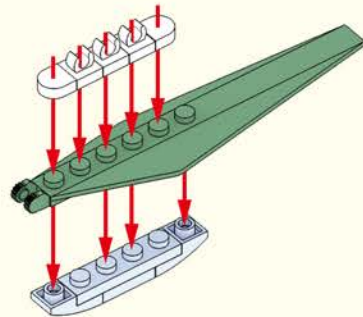



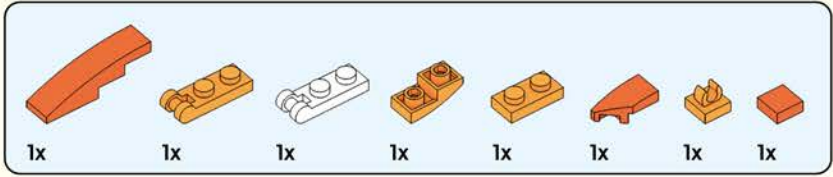

# 19

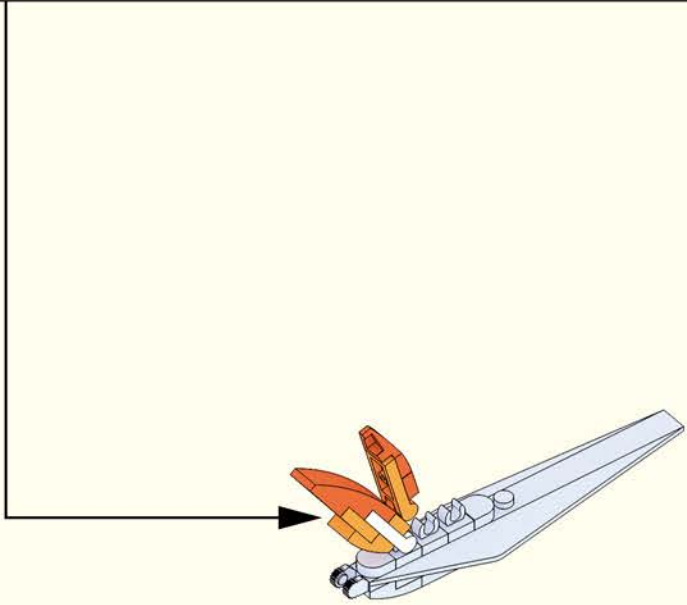
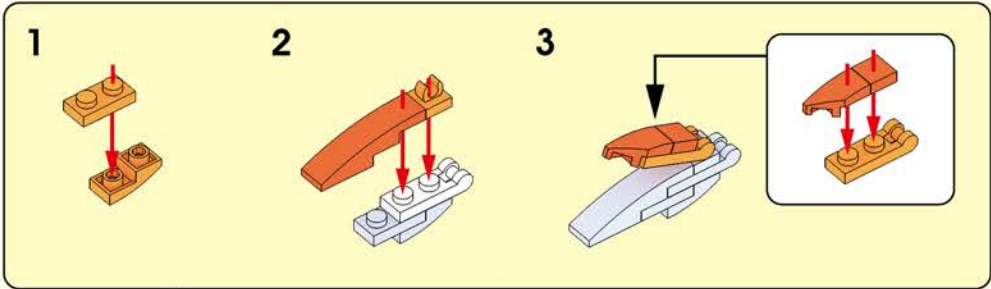

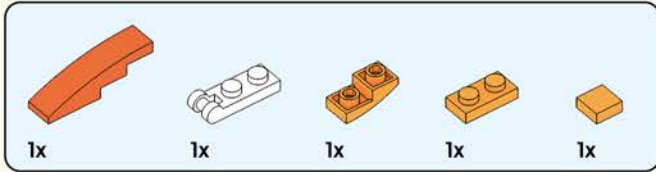

| 20 |

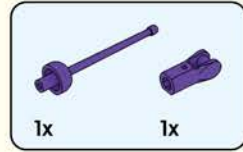
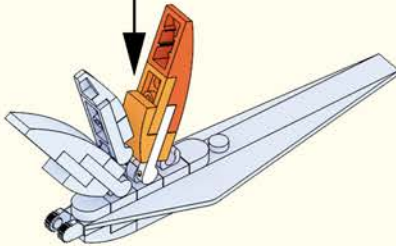
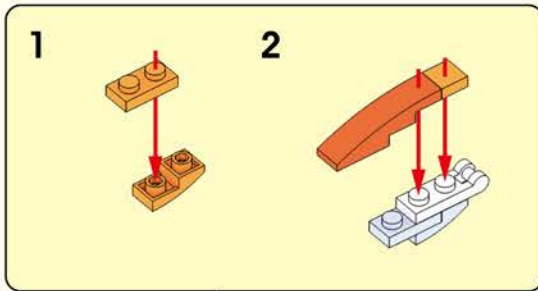

| 21 |

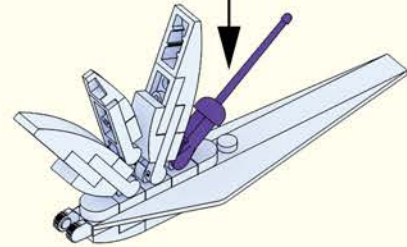
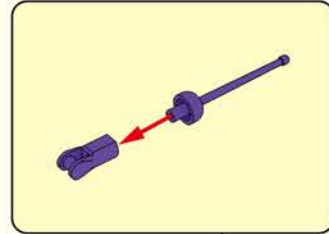

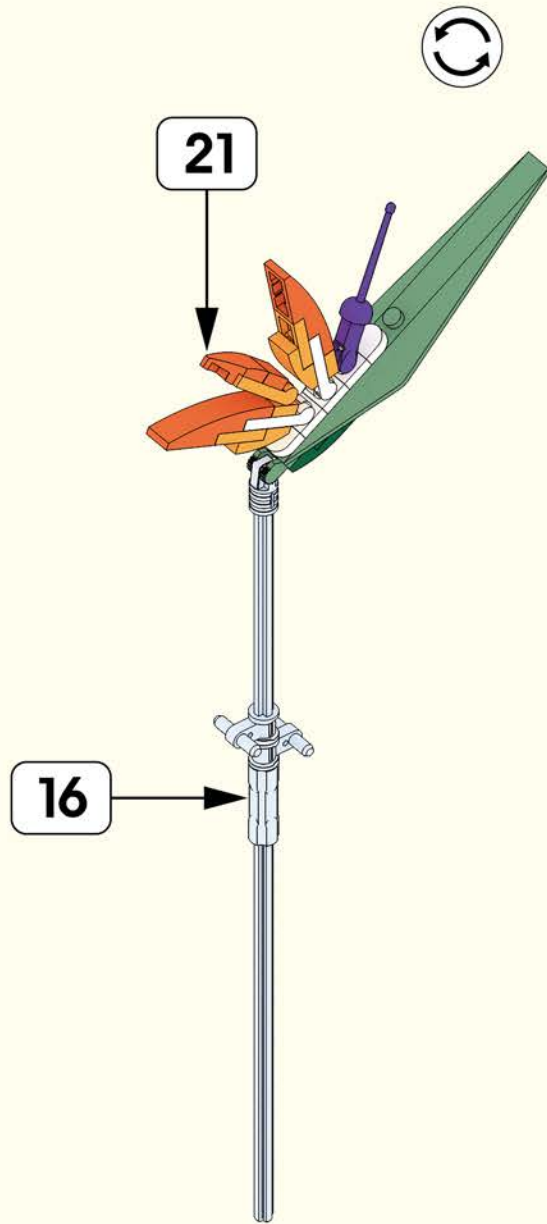

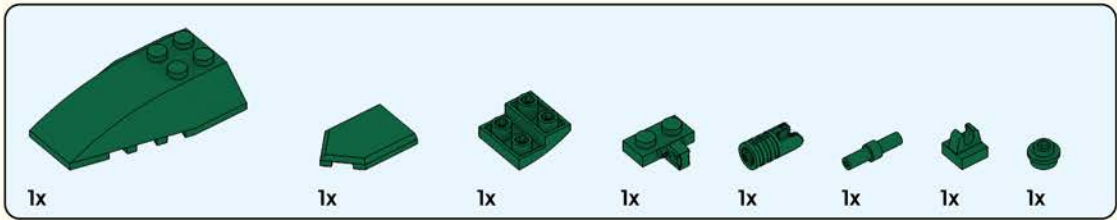

# 23

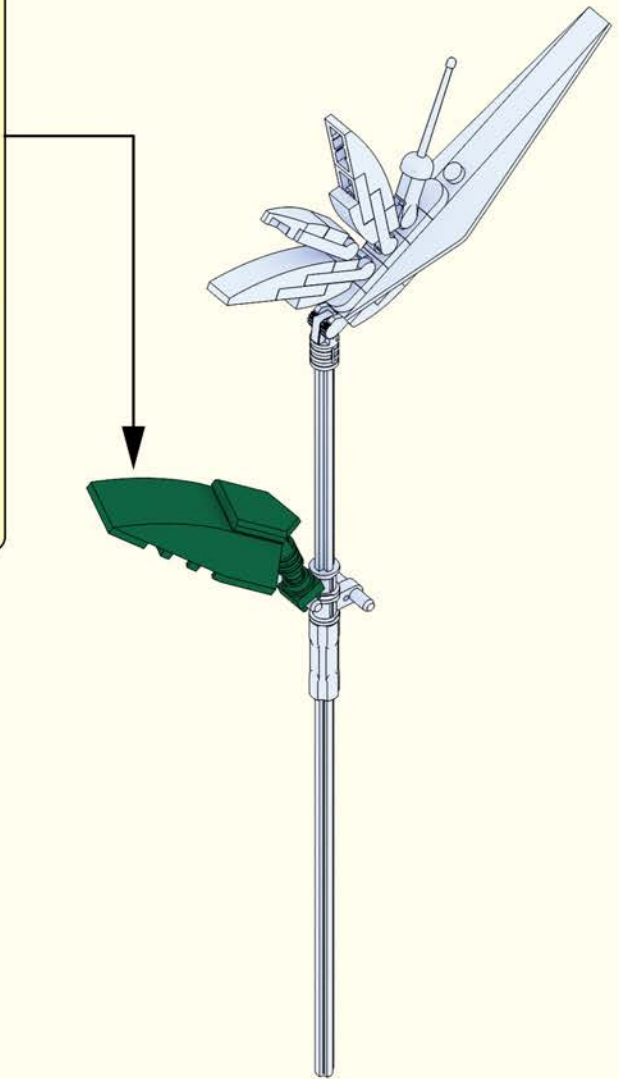
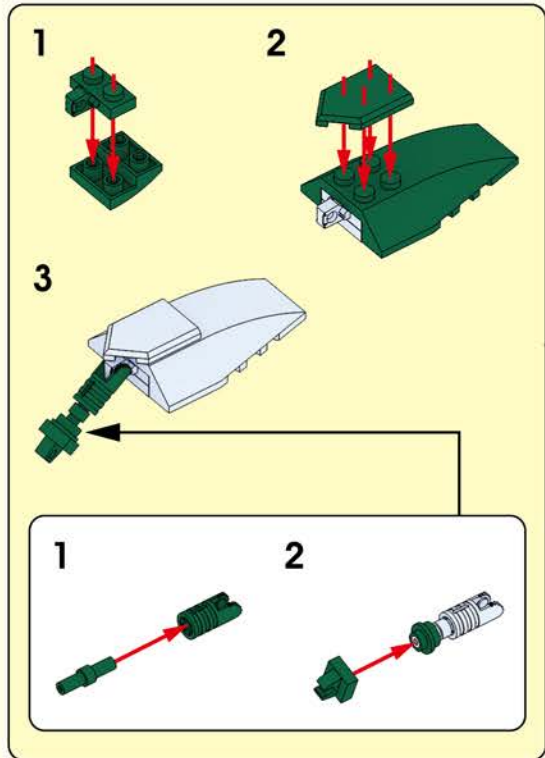

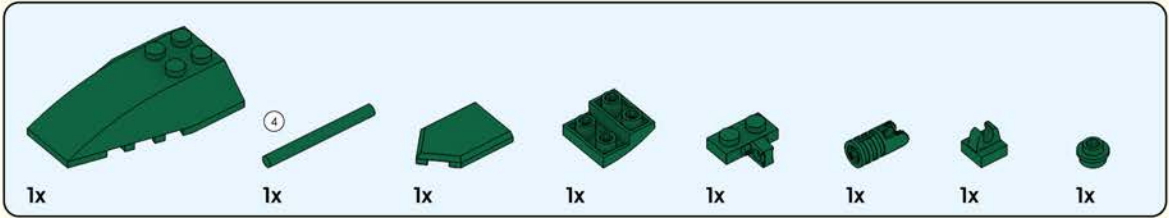

**|24|**

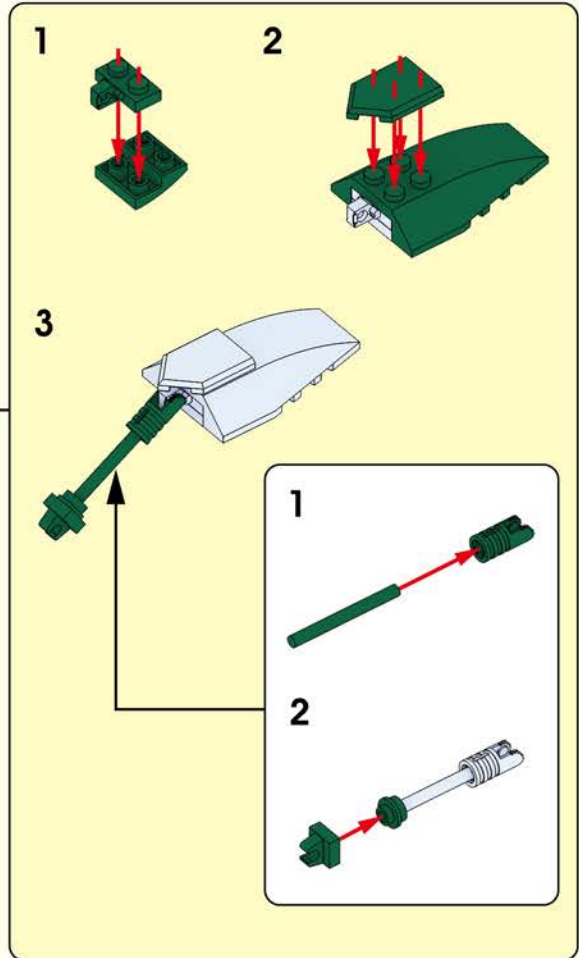
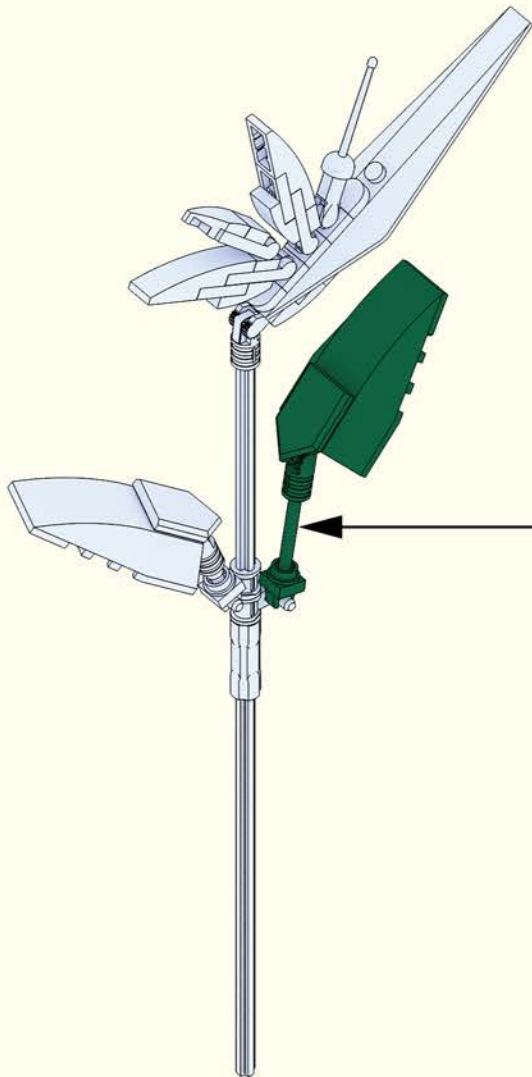

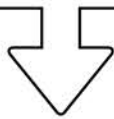

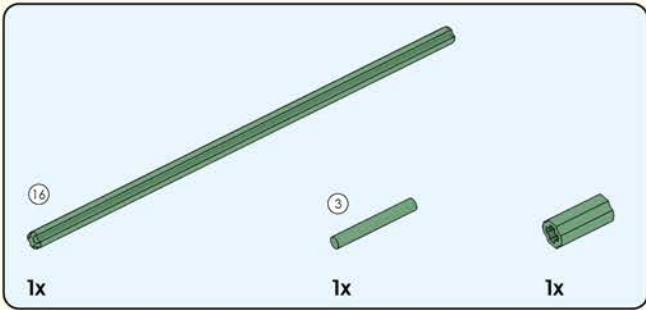
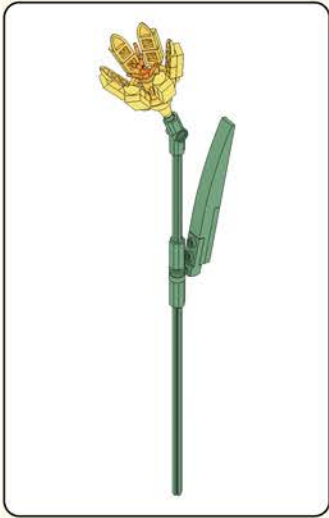

25

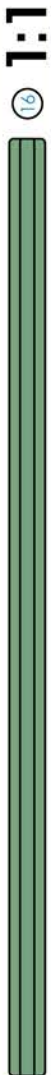

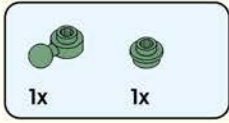

| 26 |

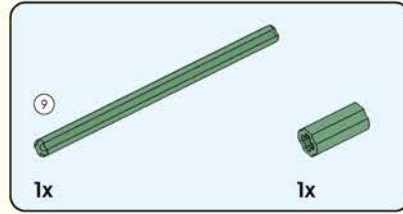
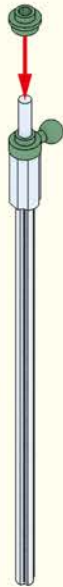

| 27 |

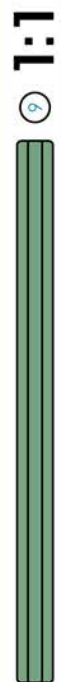



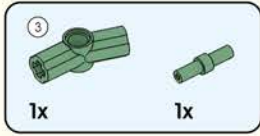

| 28 |

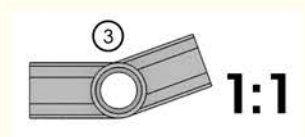
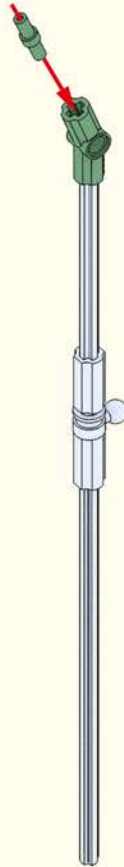

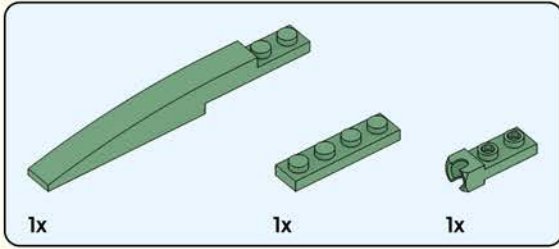

| 29 |

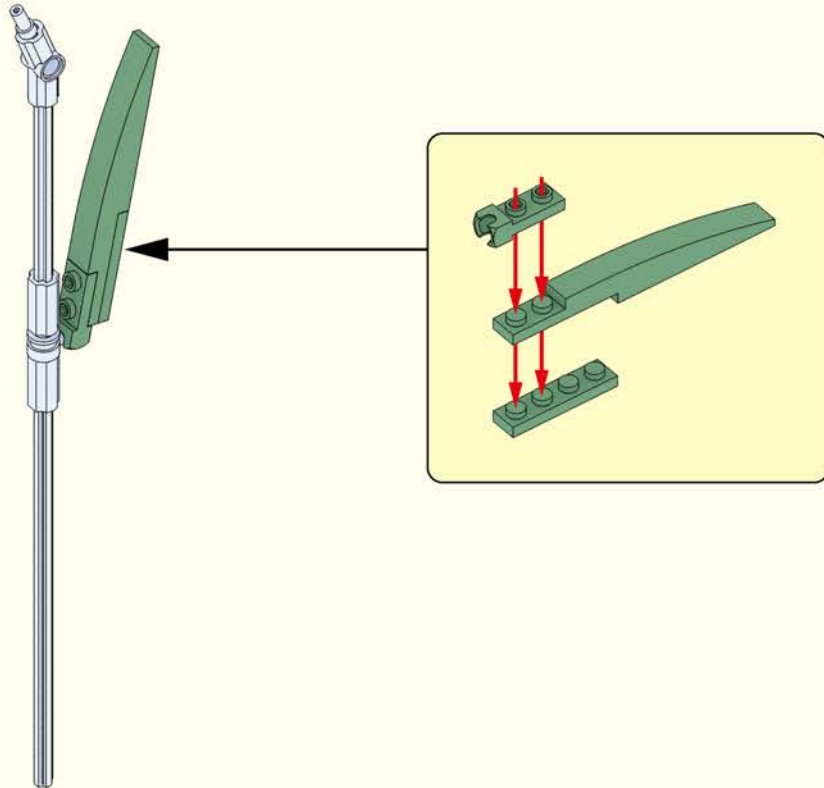

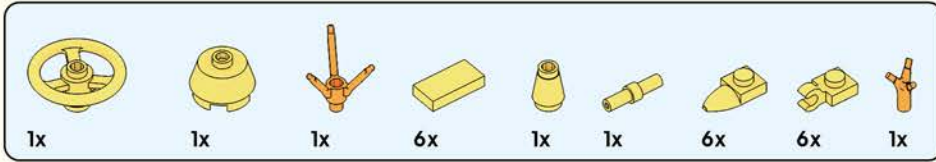

| 30 |

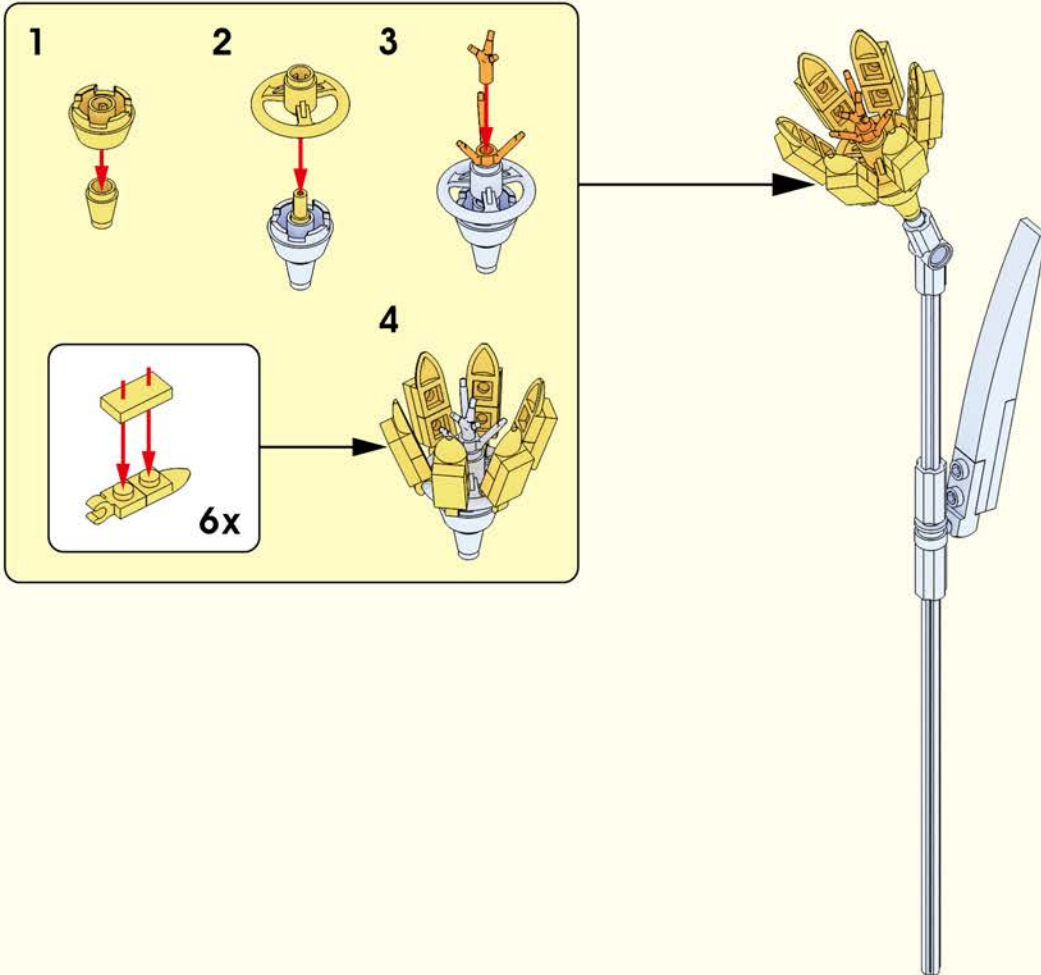

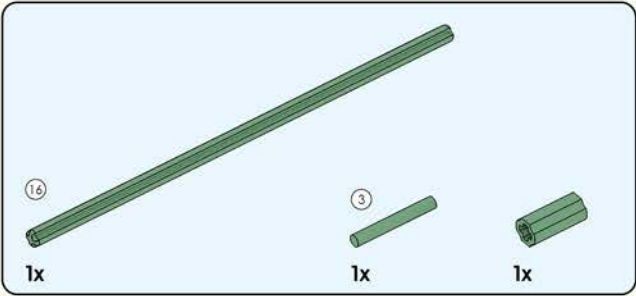
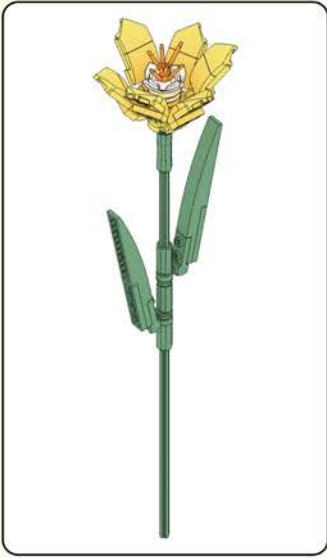

| 31 |

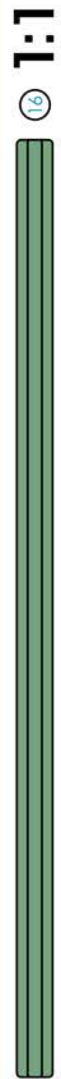

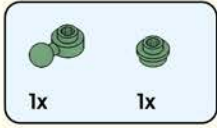

| 32 |

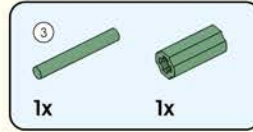
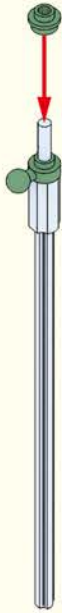

| 33 |

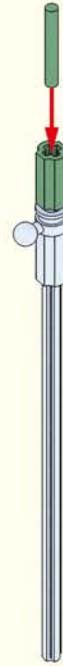

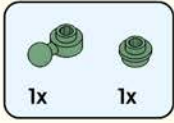

**| 34 |**

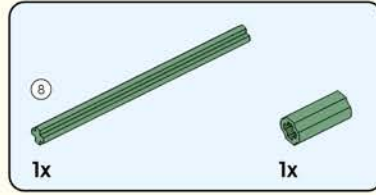
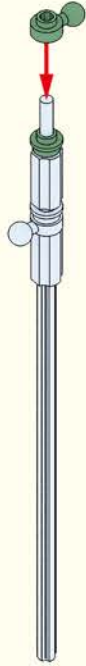

**| 35 |**

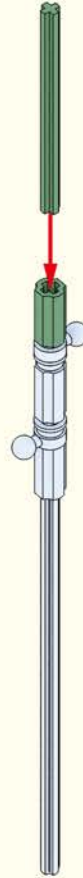

**1:1**

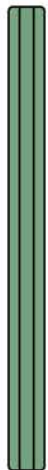

27

ONLINE [www.educiro.com](http://www.educiro.com)

Customer Service [support@educiro.com](mailto:support@educiro.com)

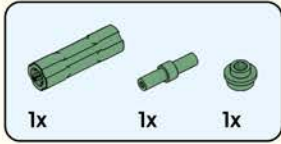

| 36 |

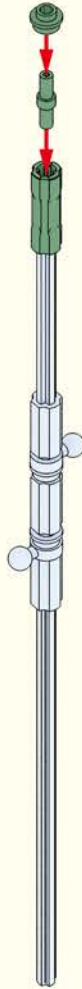

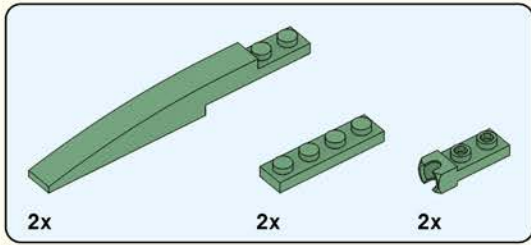

| 37 |

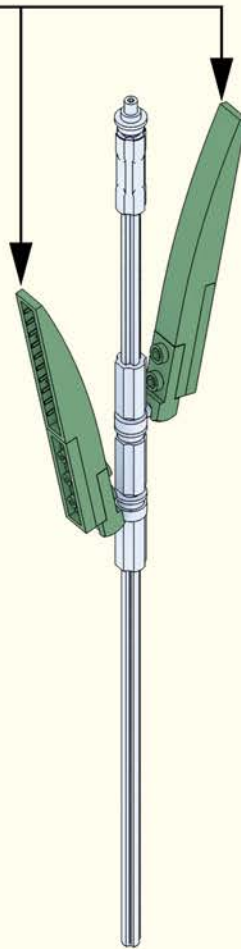
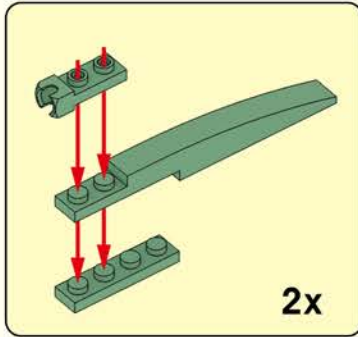





2x

| 38 |

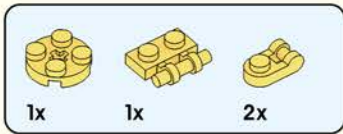
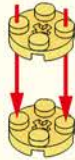

1x

1x

2x

| 39 |

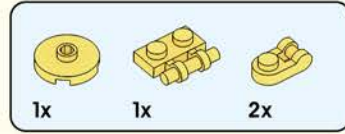
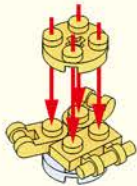

1x

1x

2x

| 40 |

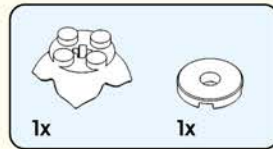
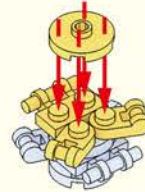

1x

1x

| 41 |

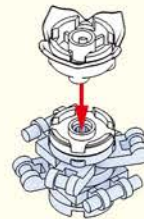

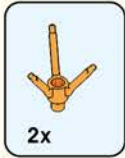

|42|

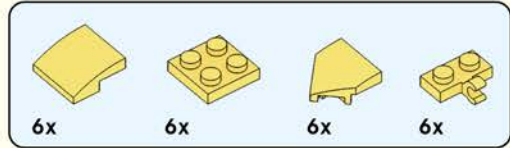
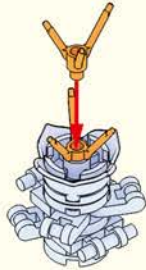

|43|

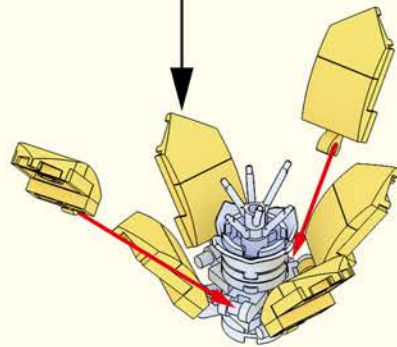
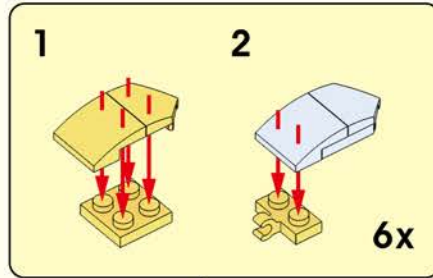

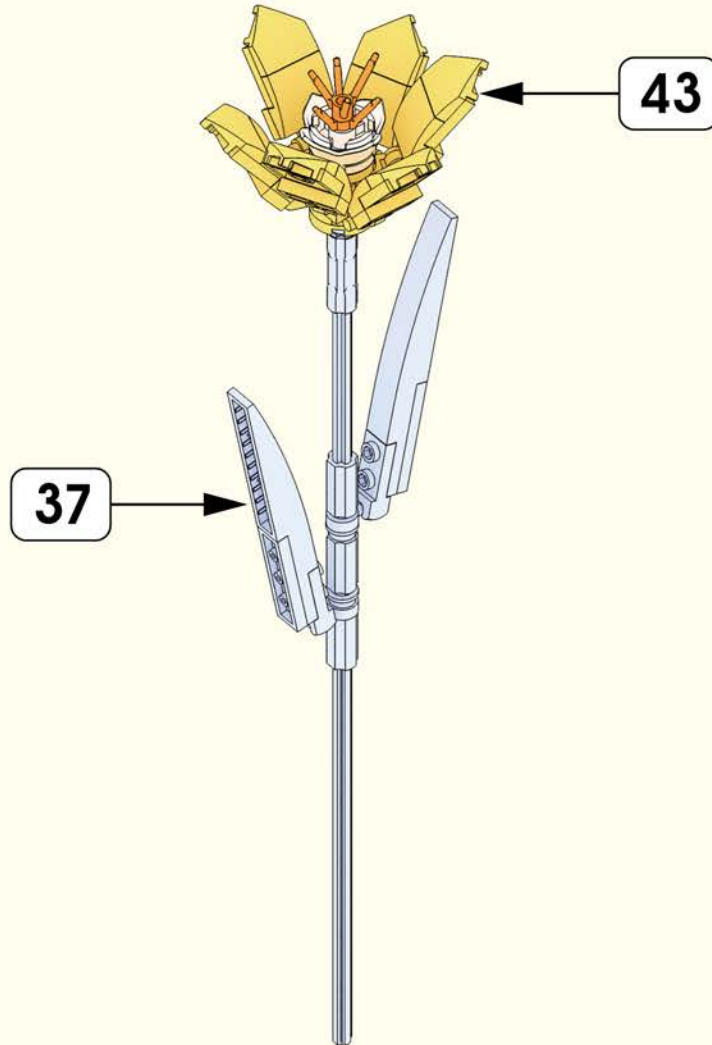

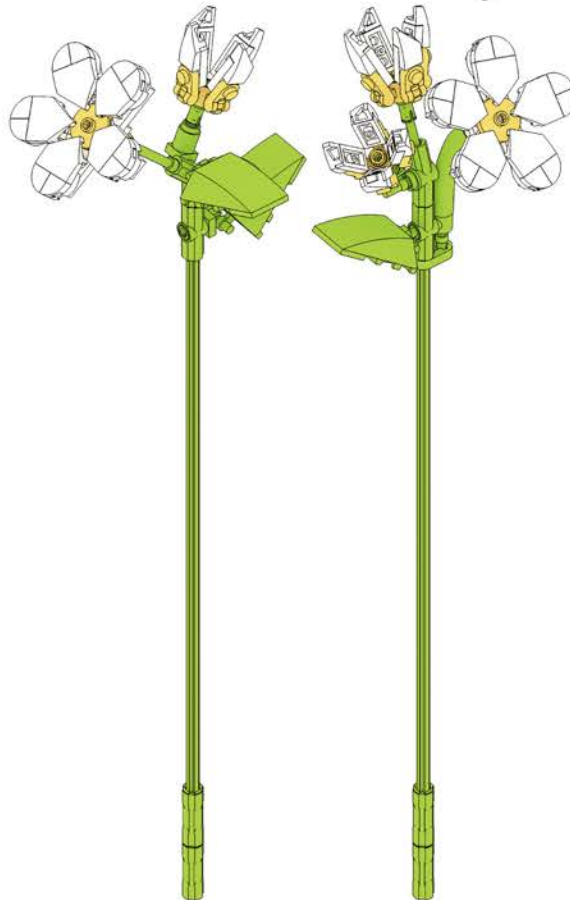
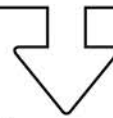
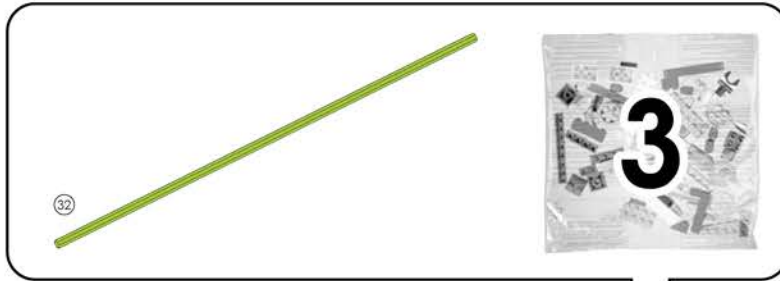

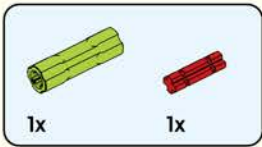

**| 45 |**



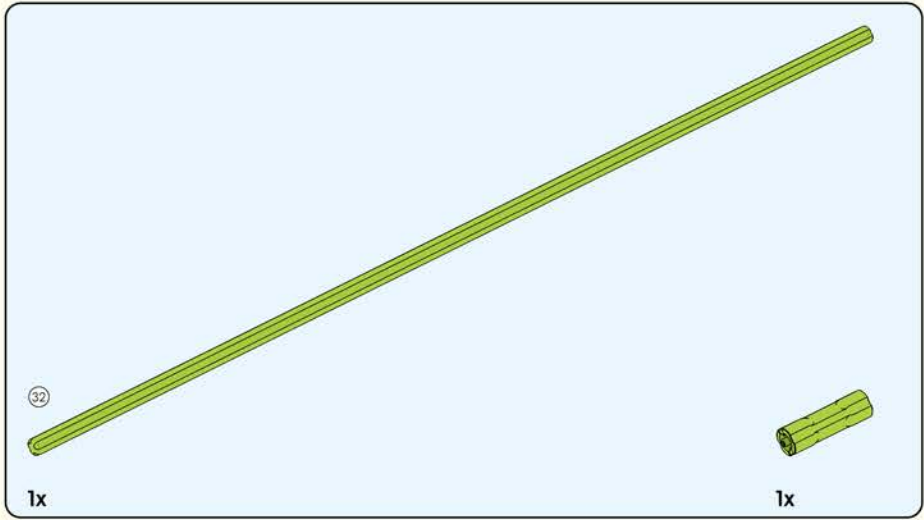

**| 46 |**



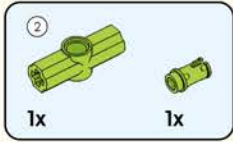

| 47 |

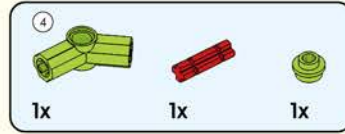
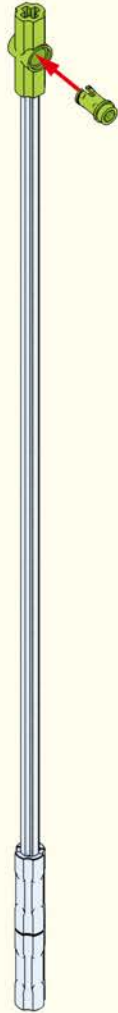

| 48 |

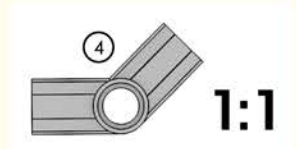
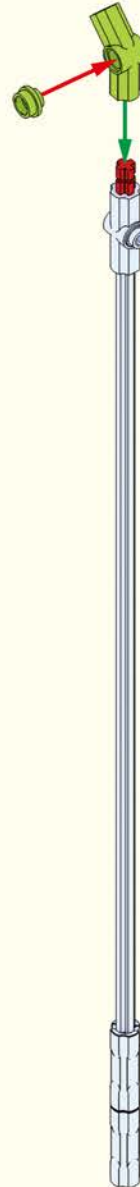

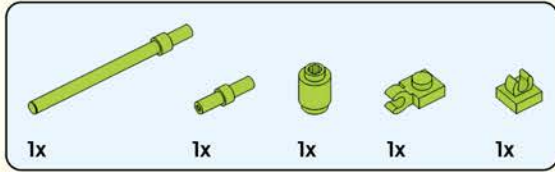

**| 49 |**

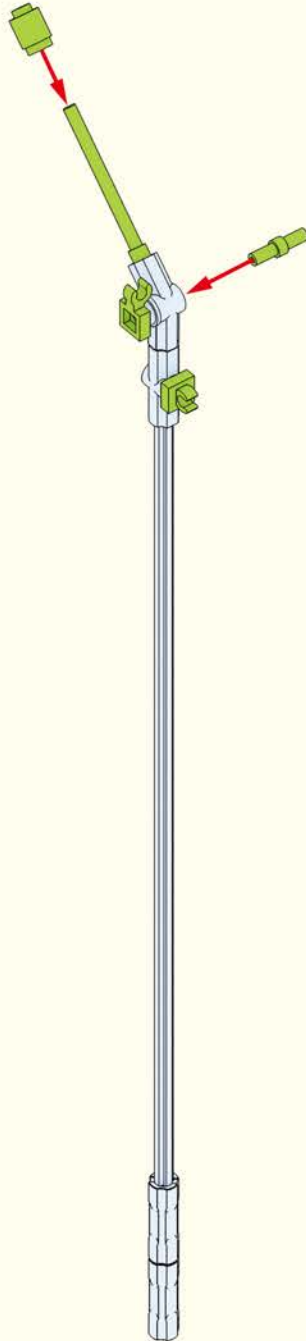



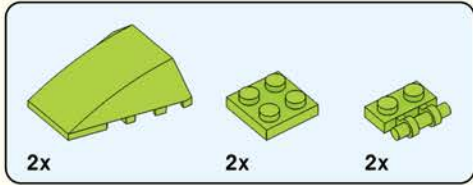

**|50|**

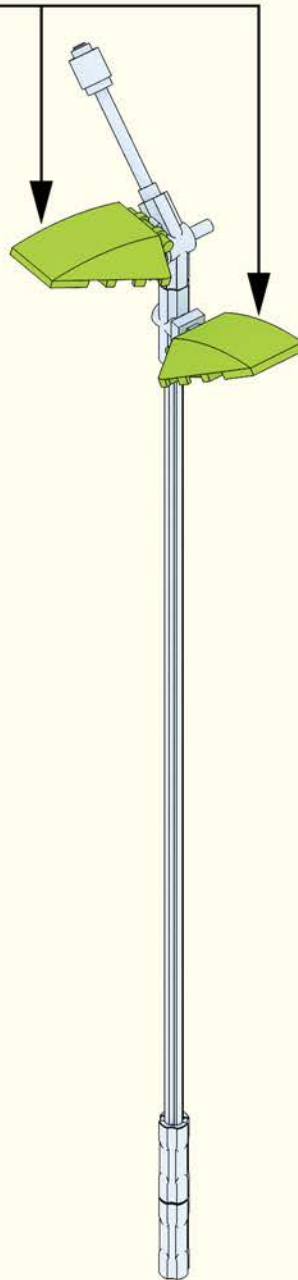
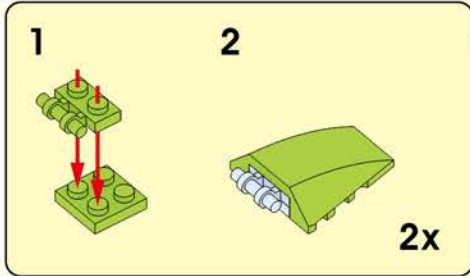

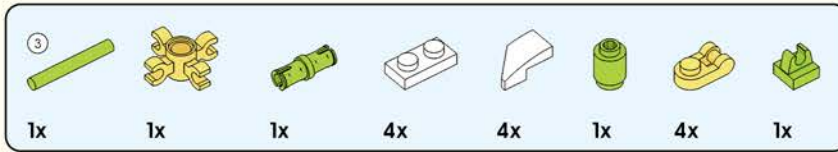

# | 51 |

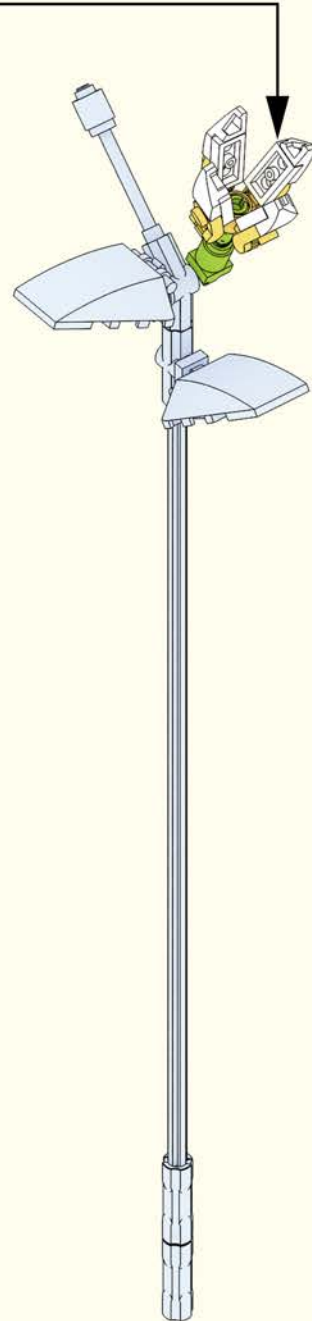
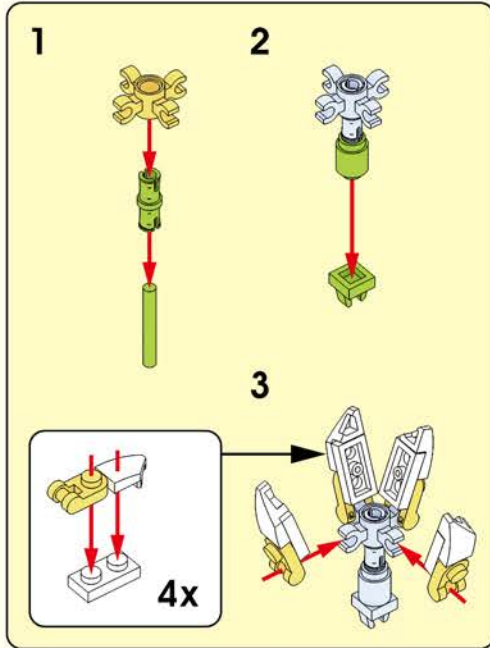

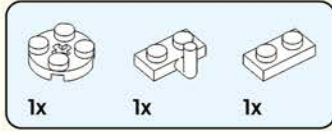
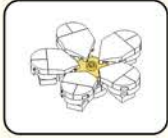

|52|

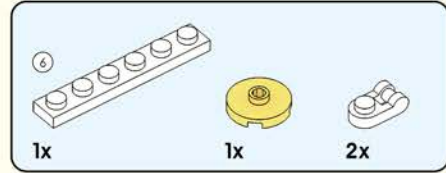
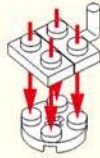

|53|

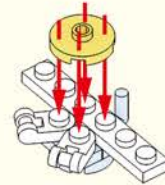

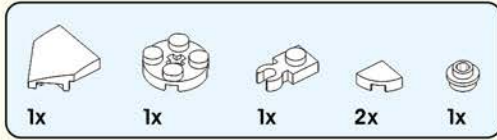

**| 54 |**

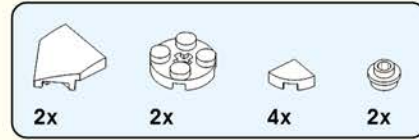
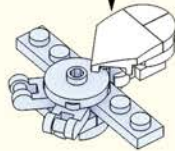
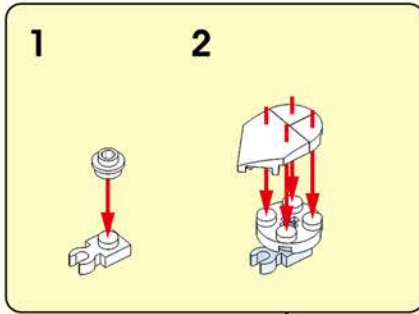

**| 55 |**

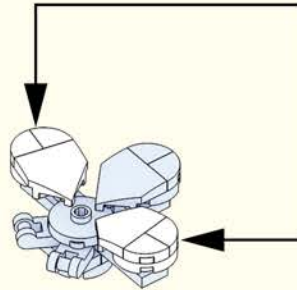
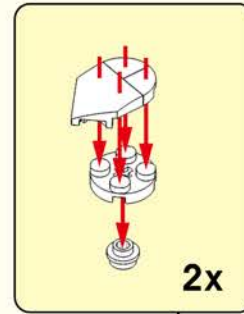

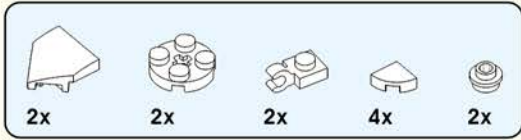

**56**

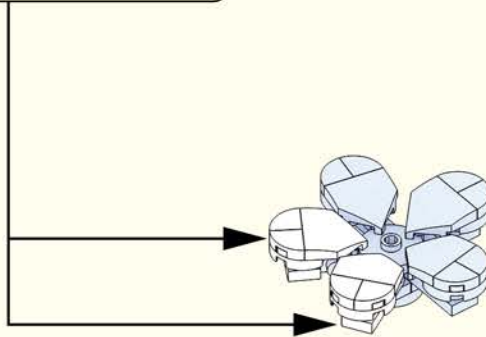
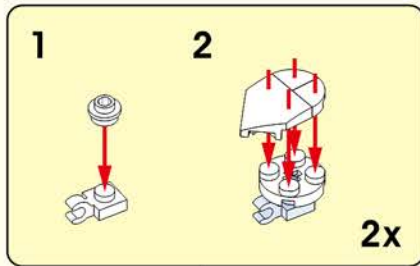

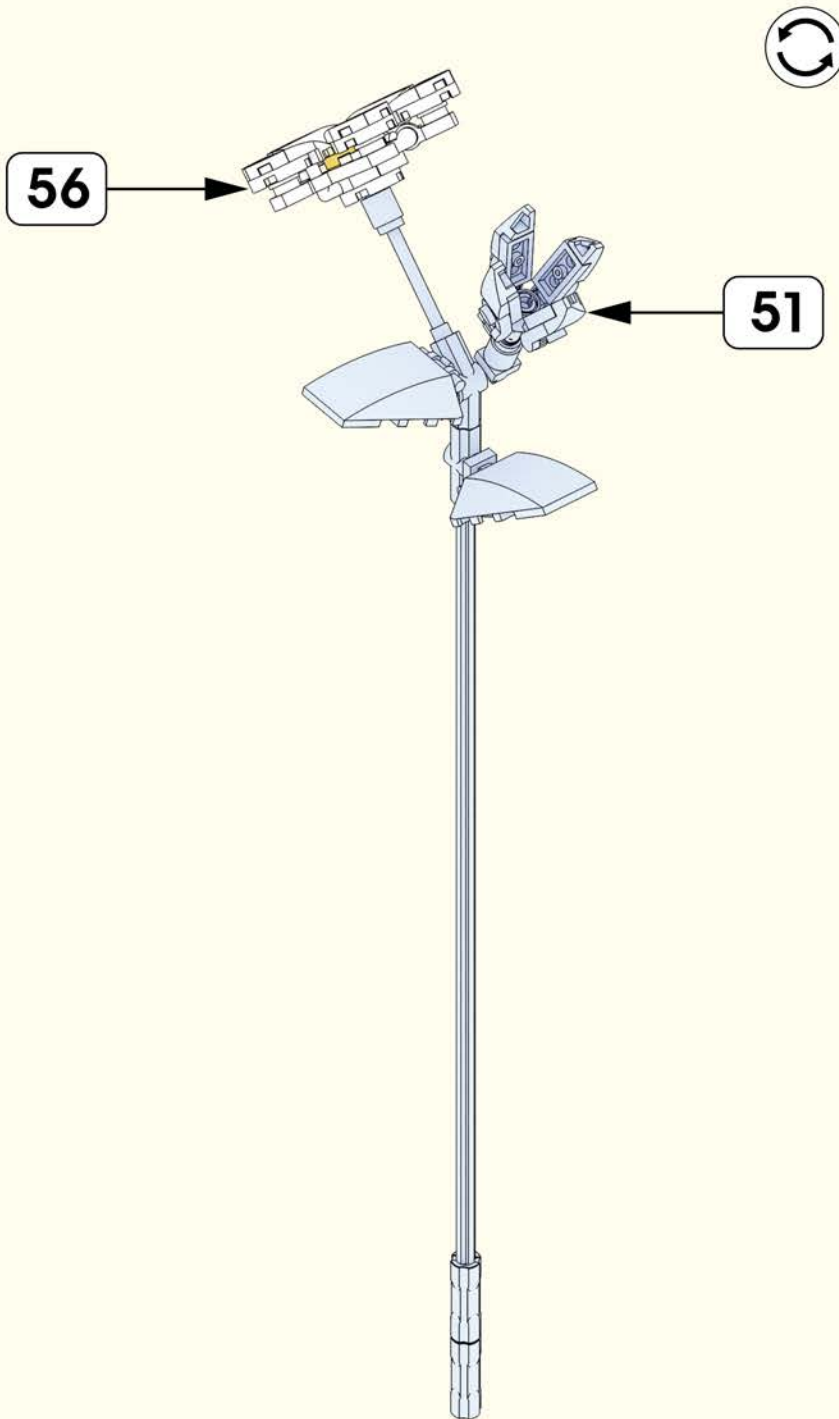

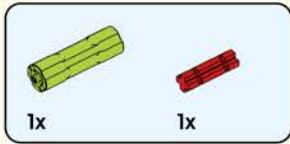

| 58 |



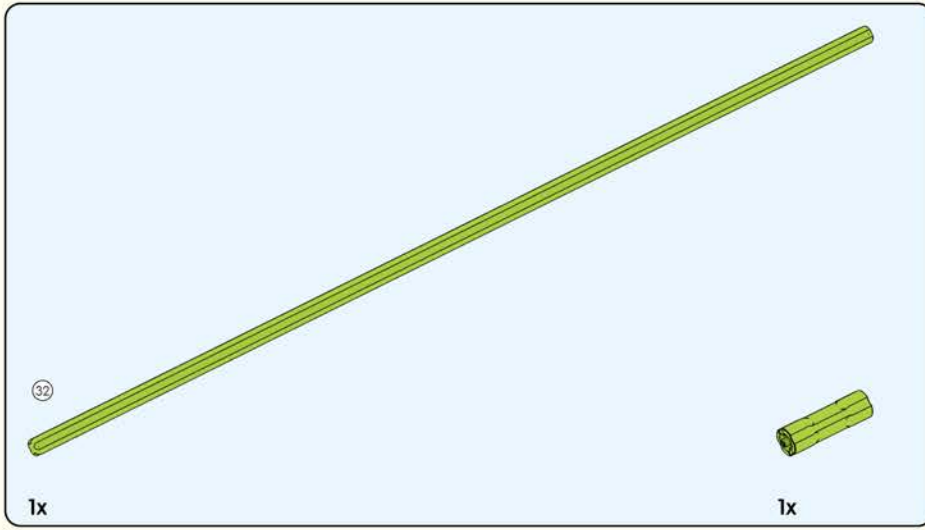

|59|





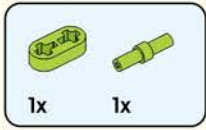

| 60 |

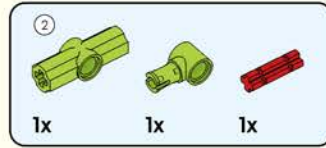
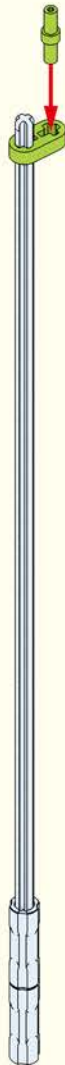

| 61 |

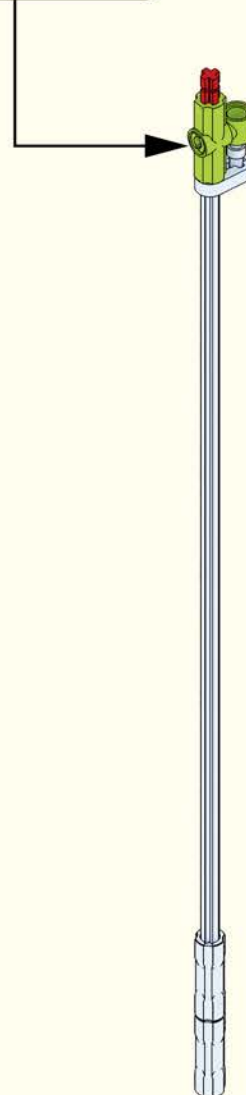
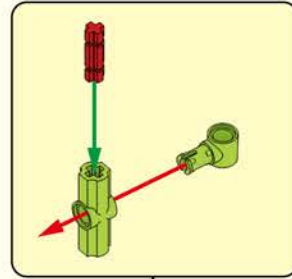

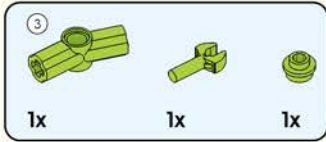

62

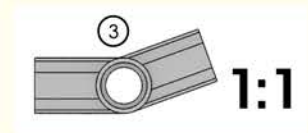
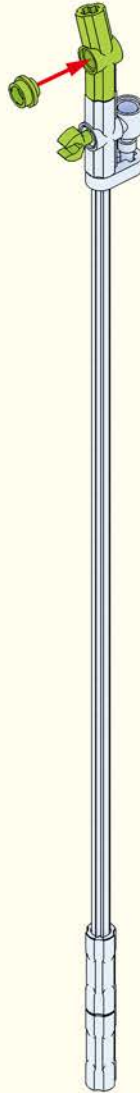

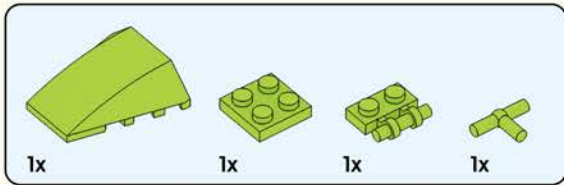

**63**

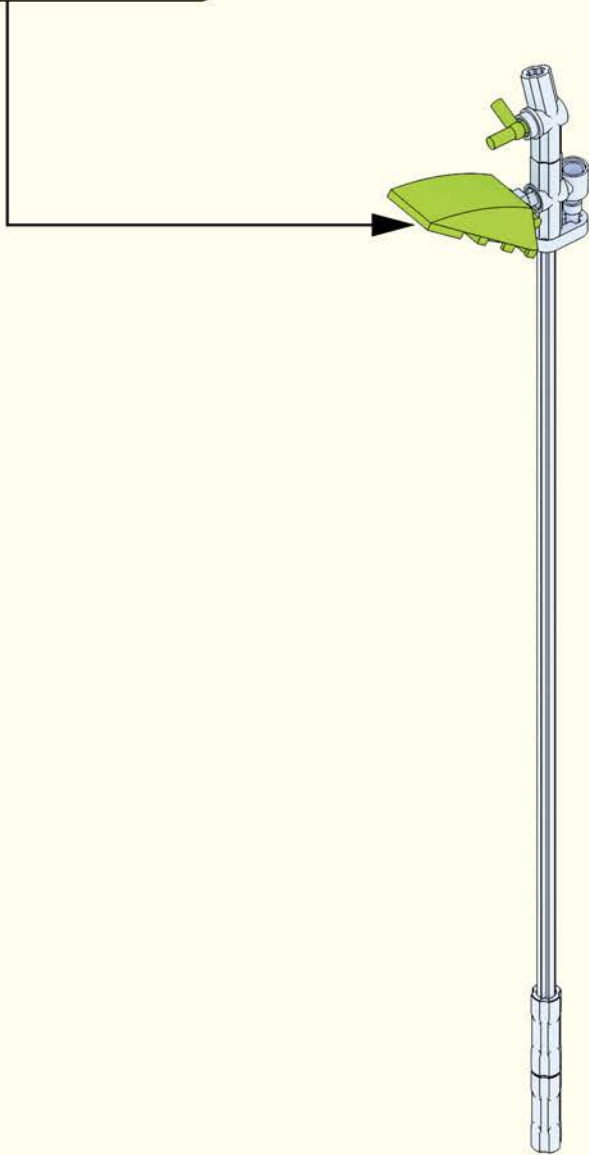
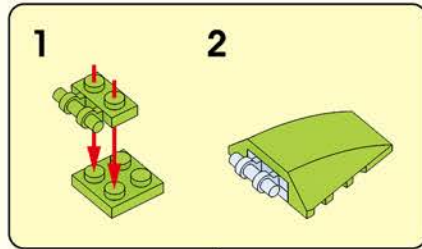

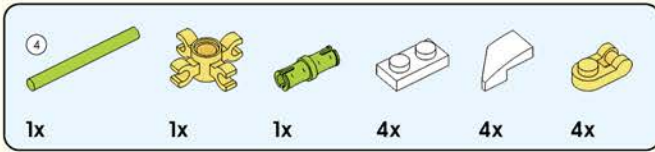

64

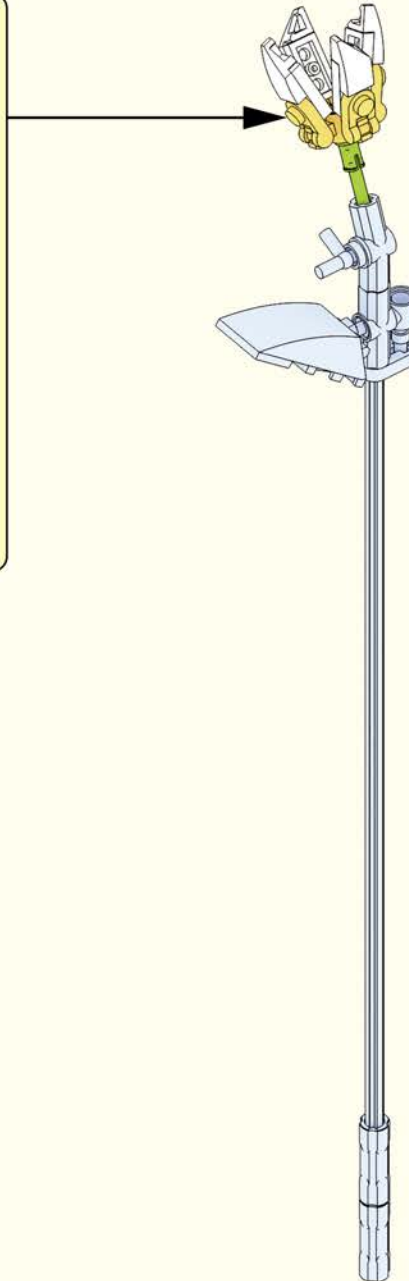
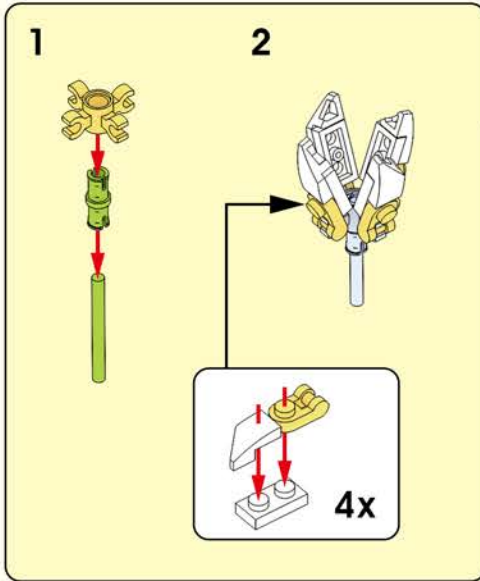

49

ONLINE [www.educiro.com](http://www.educiro.com)

Customer Service [support@educiro.com](mailto:support@educiro.com)

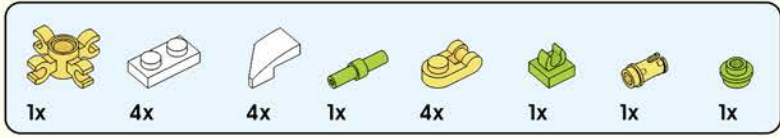

# 65

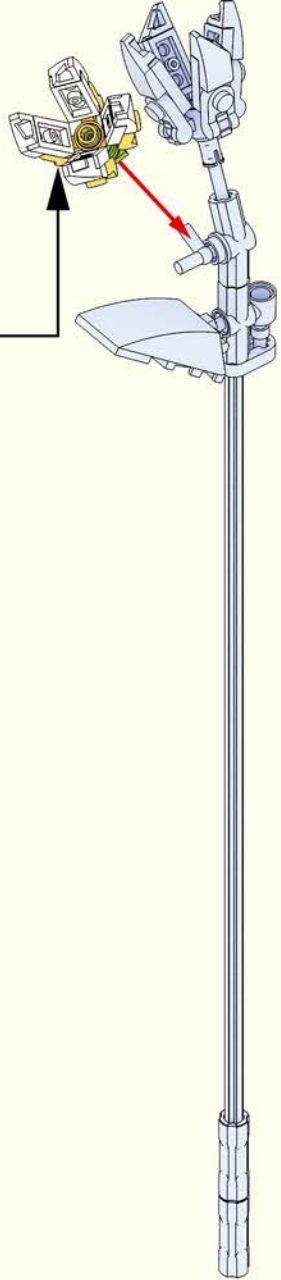
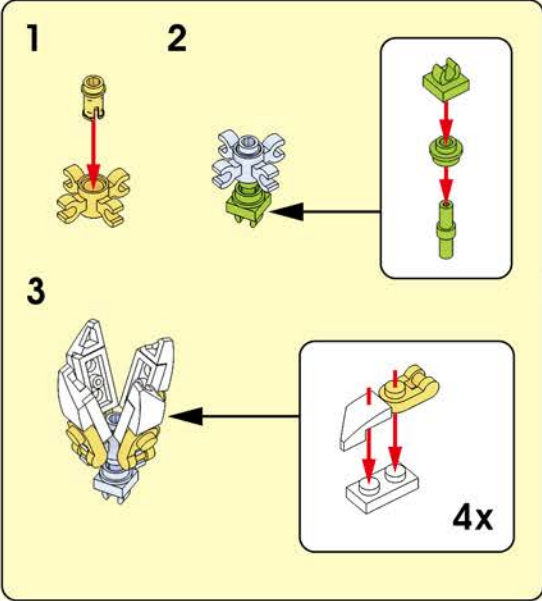

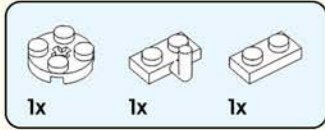
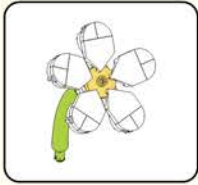

| 66 |

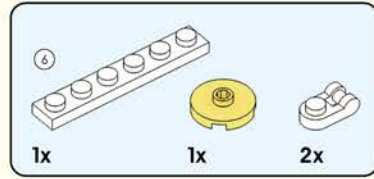
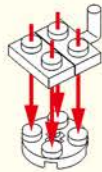

| 67 |

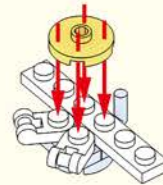

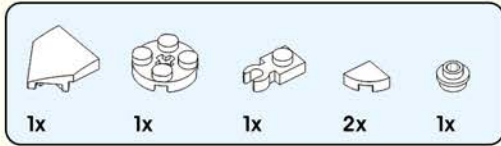

|68|

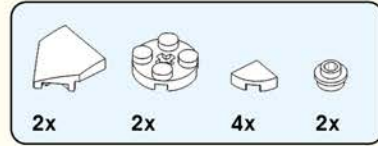
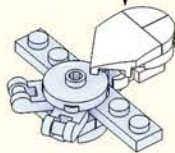
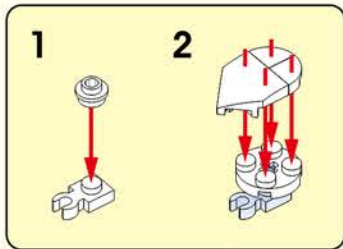

|69|

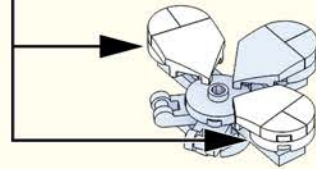
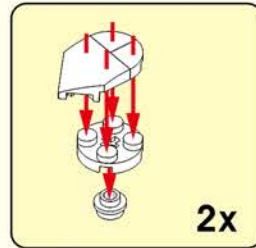

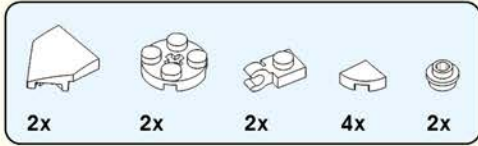

|70|

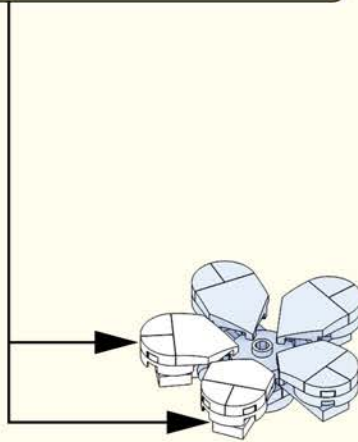
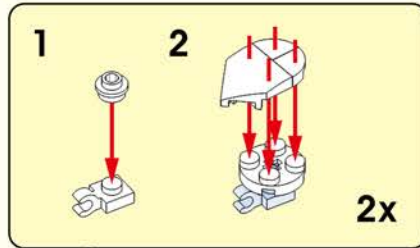



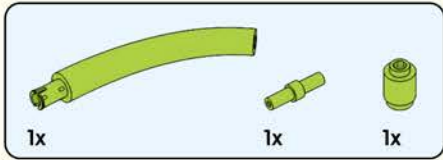

| 71 |

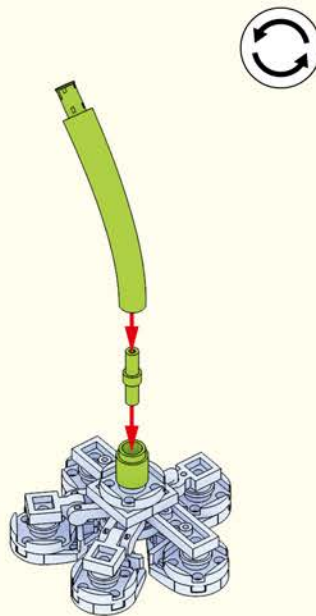

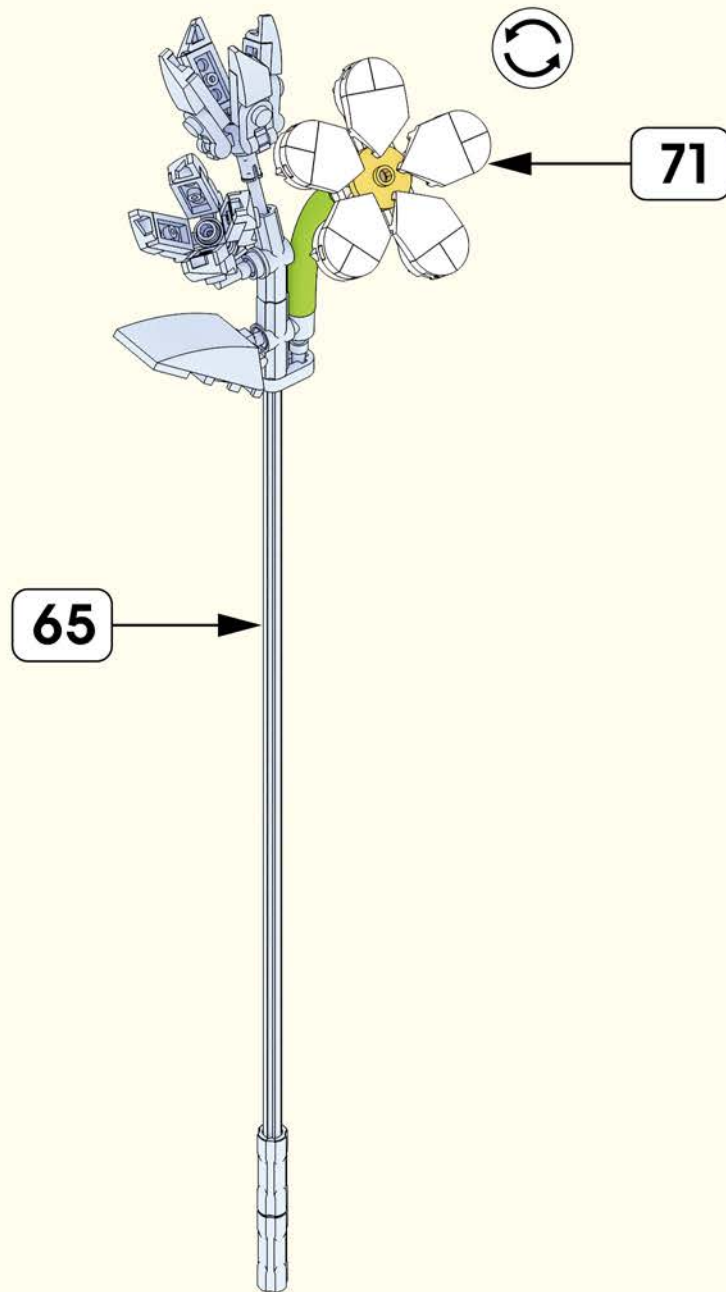

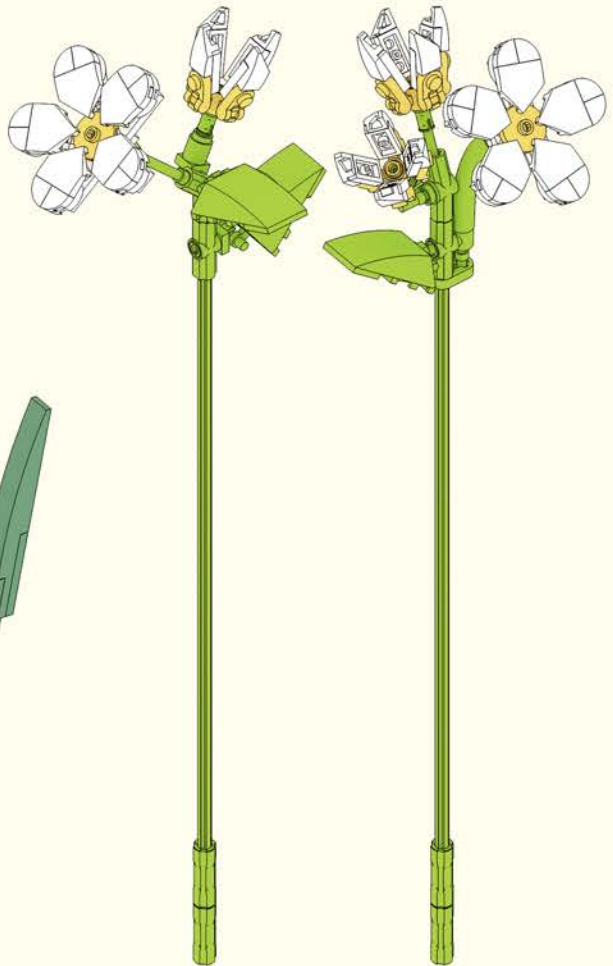
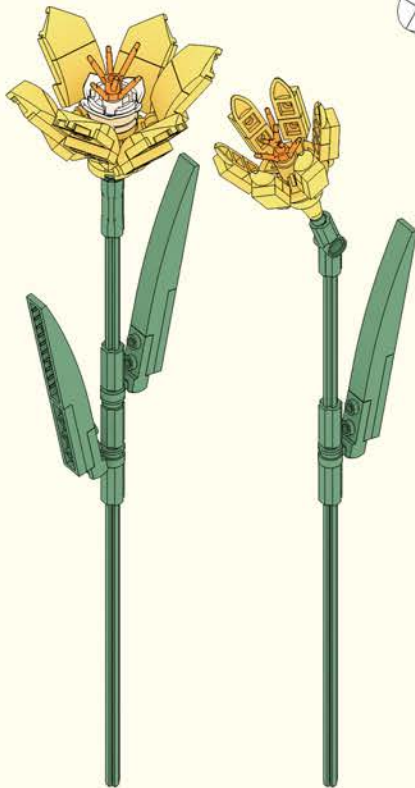



EDUCIRO